

# Smart Toilets

# Index

<b>Innovating Every Day</b>	<b>04</b>
<b>Taking Comfort To New Heights</b>	<b>10</b>
<b>The Connected Experience</b>	<b>22</b>
<b>In-Wash<sup>®</sup></b>	<b>24</b>
<b>Multiclean<sup>®</sup></b>	<b>52</b>
<b>Quick Guide</b>	<b>64</b>
<b>About Roca</b>	<b>66</b>
<b>Sustainability</b>	<b>68</b>



04



10

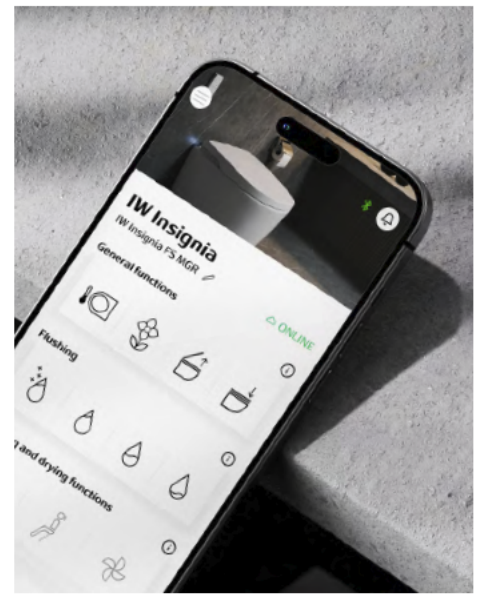

22



24



52



64



66



68

# Innovating Every Day

**With decades of experience and a deep commitment to innovation, Roca is at the forefront of creating state-of-the-art sanitary solutions that redefine comfort, hygiene, and sustainability.**

**Driven by a relentless pursuit of excellence, we continuously push the boundaries of design and engineering to deliver the highest levels of customer satisfaction. This commitment is evident in our smart toilets, which incorporate the latest technologies and avant-garde materials, offering an exceptional blend of functionality and sophistication that enhance daily living.**



## Global capacity

Our three Smart Toilet Competence Centres in Gavà (Spain), Suzhou (China) and Taiwan serve as specialised hubs for research, product development, design, assembly and production. With leading technical and R&D expertise, these centres adhere to rigorous industry-recognised testing and quality standards and are supported by a global network of manufacturing facilities.

## Industrial leadership and legacy

By embracing the latest technologies, we are revolutionising the way we design, manufacture and distribute our products. Fostering a culture of continuous improvement, we are streamlining production processes and increasing efficiency to meet the growing demand for our smart toilets, setting the course for the future of sanitary solutions.

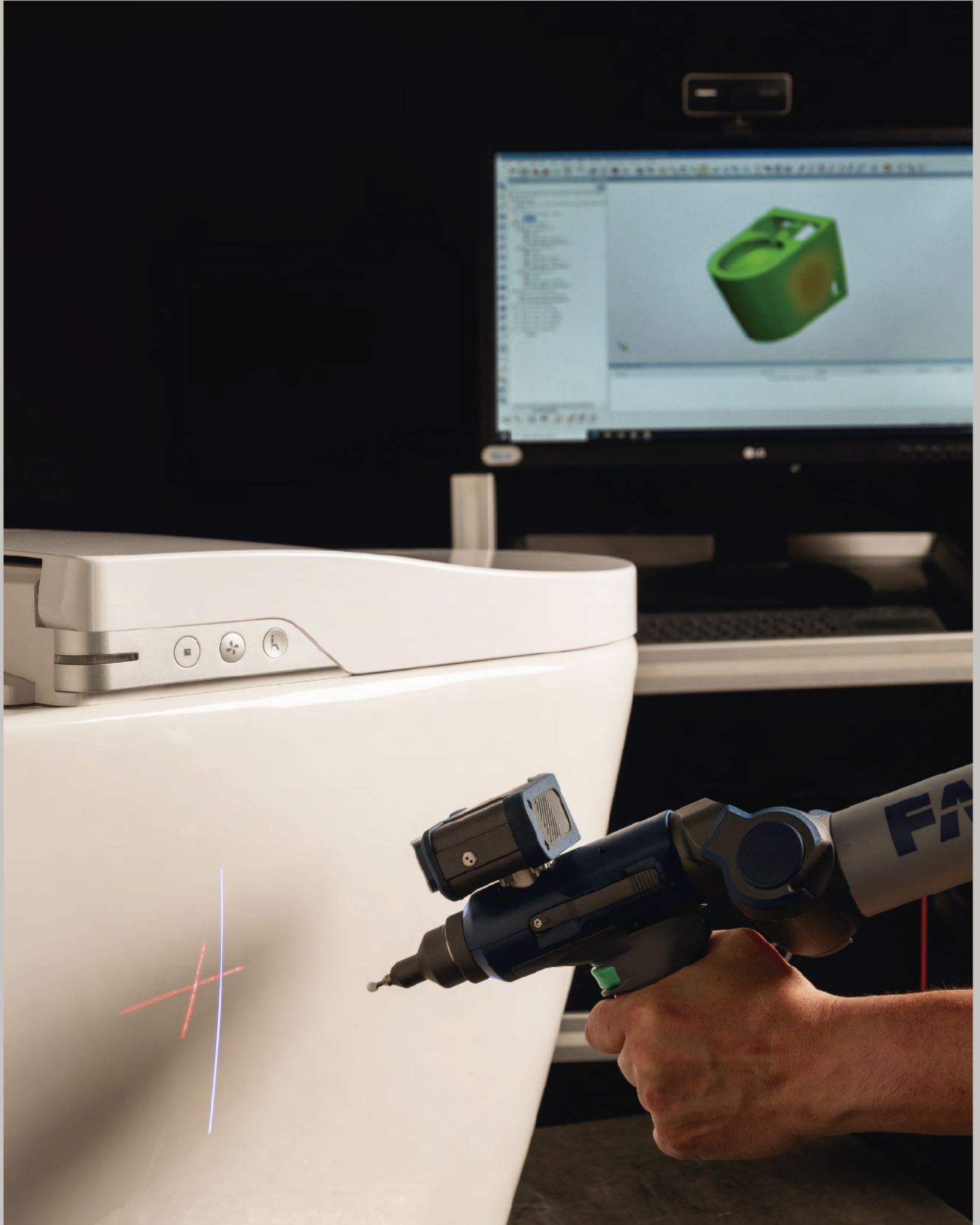



## Inspiring innovation

Our extensive manufacturing expertise, combined with the know-how of our competence centres, enables us to continually push the boundaries to deliver the best products and pioneer authentic solutions in our cutting-edge collections of smart toilets. Focusing on the most crucial elements of smart toilet functionality our commitment to innovation is exemplified by our patented washing and drying developments.

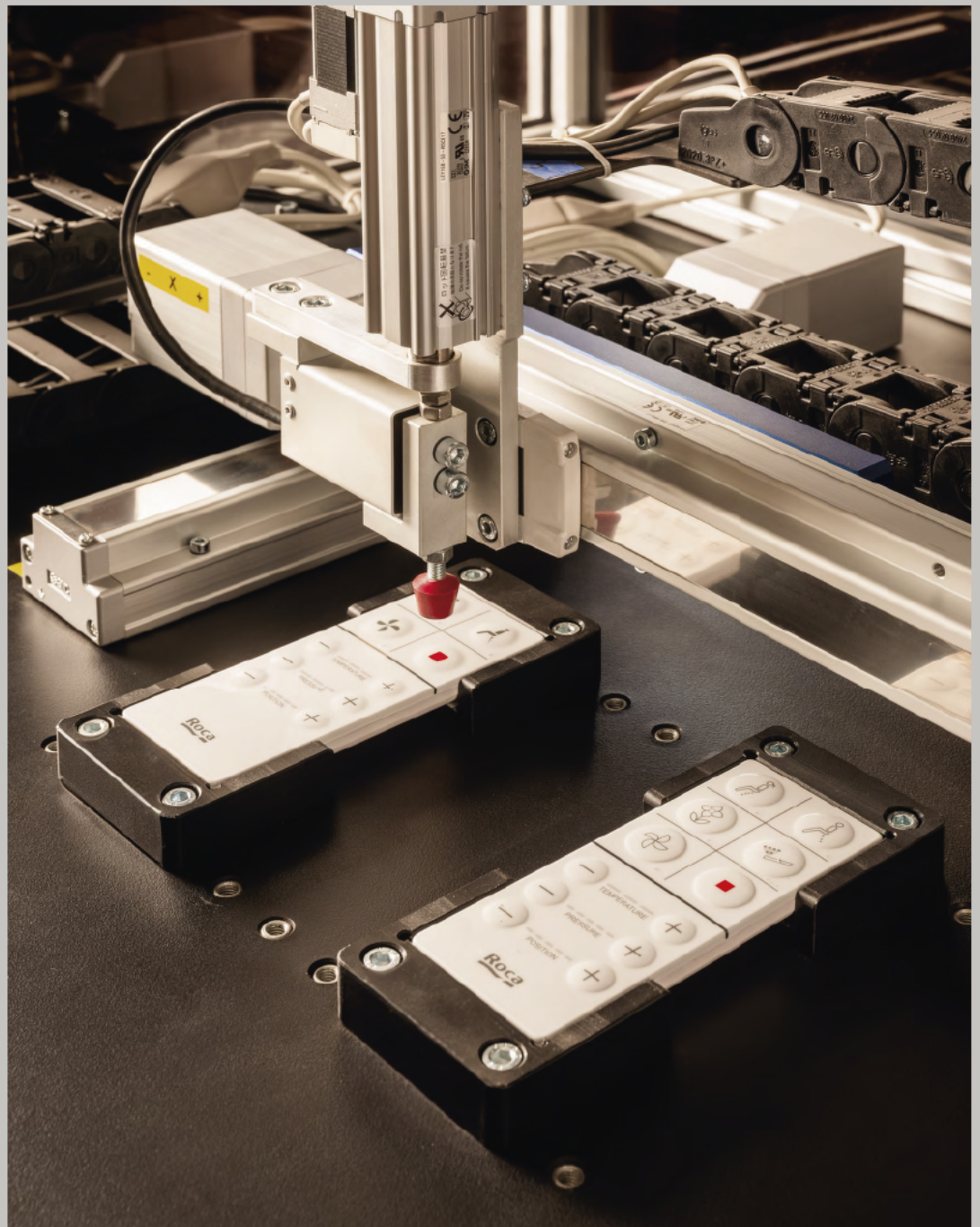

## A hallmark of quality

As a global company with roots in Barcelona, we have been a leader in bathroom solutions for over 100 years. Our extensive experience has earned us the trust of professionals, contractors and consumers alike. To ensure the highest standards of quality, each product is meticulously crafted and rigorously tested at our Competence Centre in Gavà. To ensure safety standards, all In-Wash® toilets comply with European regulations, including EN1717, one of the most important regulations to prevent water backflow.

# Taking Comfort to New Heights

## Smart Toilets



In this age of rapid technological advancement, smart devices have become an essential part of everyday life, extending their influence into our homes. In the bathroom, this evolution has reached unprecedented levels, introducing a myriad of innovative solutions to enhance comfort and hygiene. Among these developments, smart toilets have emerged as one of the revolutionary bathroom fixtures that have redefined the approach to personal hygiene practices and transformed the entire bathroom experience.

Smart toilets represent a significant leap forward in bathroom technology, offering a blend of comfort, hygiene, and convenience that surpasses standard toilets. These advanced devices use water for a gentle and natural cleaning experience, ensuring superior personal hygiene, and are equipped with advanced innovations to effortlessly maintain impeccable bathroom cleanliness.

The benefits of smart toilets in the modern bathroom are undeniable. Their versatility, combined with advanced hygiene features and personalised settings, make smart toilets a practical and luxurious addition to any household. These smart devices not only improve daily routines, but also contribute to a cleaner, more comfortable, and more convenient bathroom experience, making them an essential part of contemporary living.

Roca offers versatile solutions tailored to diverse needs and budgets, ranging from entry-level smart toilets to high-end, feature-rich options. Incorporating In-Wash® toilets and Multiclean® seats into a bathroom, represents a significant step into the future of bathroom technology, where innovation and everyday convenience come together.

The sleek design of In-Wash® smart toilets integrates seamlessly with all bathroom styles and perfectly complements Roca bathroom collections, while the MultiClean® shower seats are compatible with any Roca toilet, ensuring accessibility for all types of homes without the need for extensive renovations.

The sophisticated washing and drying systems of these smart toilets can be tailored to individual preferences through an easy-to-use control panel and an extended mobile app. In addition, the integration of smart technology through Roca Connect allows users to schedule maintenance, receive notifications, and gain valuable usage insights.



## The perfect wash

The core functionality of a smart toilet is centred around washing and drying solutions, with Roca leading the way, offering maximum customisation through separate water sources for front and rear washing.

Several patented innovations allow each smart toilet to deliver optimal hygiene and comfort with superior results. These solutions use instant water heating systems to ensure a continuous supply of hot water for consecutive use by multiple users.



Soft Front Wash In-Wash® Insignia



Rear Wash Multi-Stream In-Wash® Insignia



Soft Front wash with Airtech In-Wash® Ona, In-Wash® The Gap and Multiclean® M4

### **Rear wash with Multi-Stream**

The rear wash with Multi-Stream gives users a choice of three different rear wash modes – soft, intense or mixed – delivered through a separate outlet from the front wash, allowing for tailored cleaning to suit different preferences.

### **Soft front wash**

This functionality uses nine different sources for perfect water distribution of water and a superior level of front cleaning.

### **Rear and front wash with Airtech technology**

This technology ensures highly effective cleaning using advanced engineering that injects air into the water stream.

### **Maximum customisation**

Adjustable nozzle positions, water pressure, temperature and oscillation ensure ideal water distribution for a better washing experience. These functions can be personalised and conveniently controlled. In addition, the mobile app allows for the creation of user profiles, automatic drying after washing, and the selection of washing and drying times.

# State-of-the-art drying

After washing comes drying, an essential feature of smart toilets designed to enhance user comfort. Options range from drying with warm air with adjustable temperature levels for a more tailored experience, to high-end drying technology inspired by the Coanda effect for precise and efficient drying. Users can easily personalise and control these drying features via a mobile phone app.

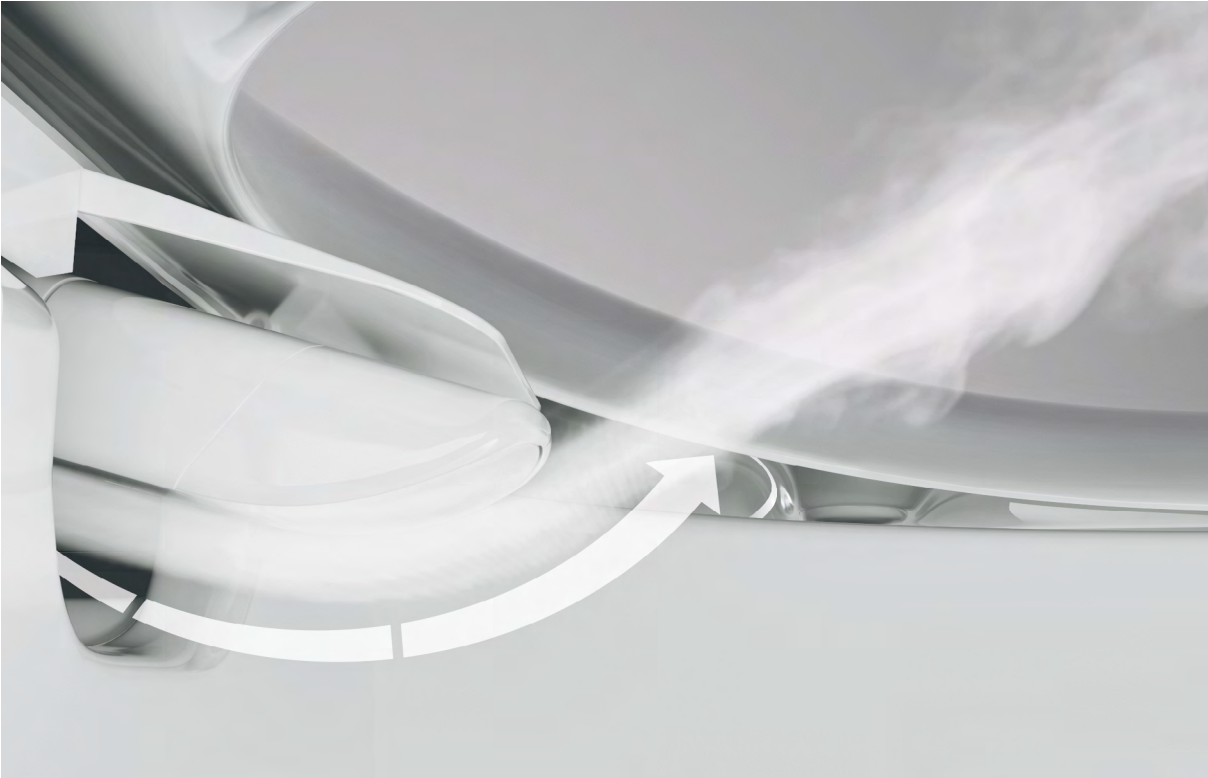

Dryer Conda In-Wash® Insignia



Dryer Conda In-Wash® Ona and Multiclean® M4

### **Coanda Effect Dryer**

High-performance dryer with the Coanda effect, in which fluids tend to follow the surfaces. This principle was a source of inspiration in the design of the nozzle, which directs air to the precise point where it is needed. With the Coanda effect air is directed to a specific area for peak drying performance at any power level.

## A unique combination of comfort and style

Smart toilets are designed to make everyday life better, with a range of advanced features that put wellbeing first and ensure that every use is a pleasurable experience.

### Heated Seat

A heat seat adds to the luxury experience by distributing heat evenly for extra comfort. Users can choose from four different temperature levels, either continuously or scheduled via the app.

Roca has also developed an exclusive quick release system for In-Wash® Insignia. This makes it easy to remove for cleaning, despite its heating system.



Quick release heated seat In-Wash® Insignia

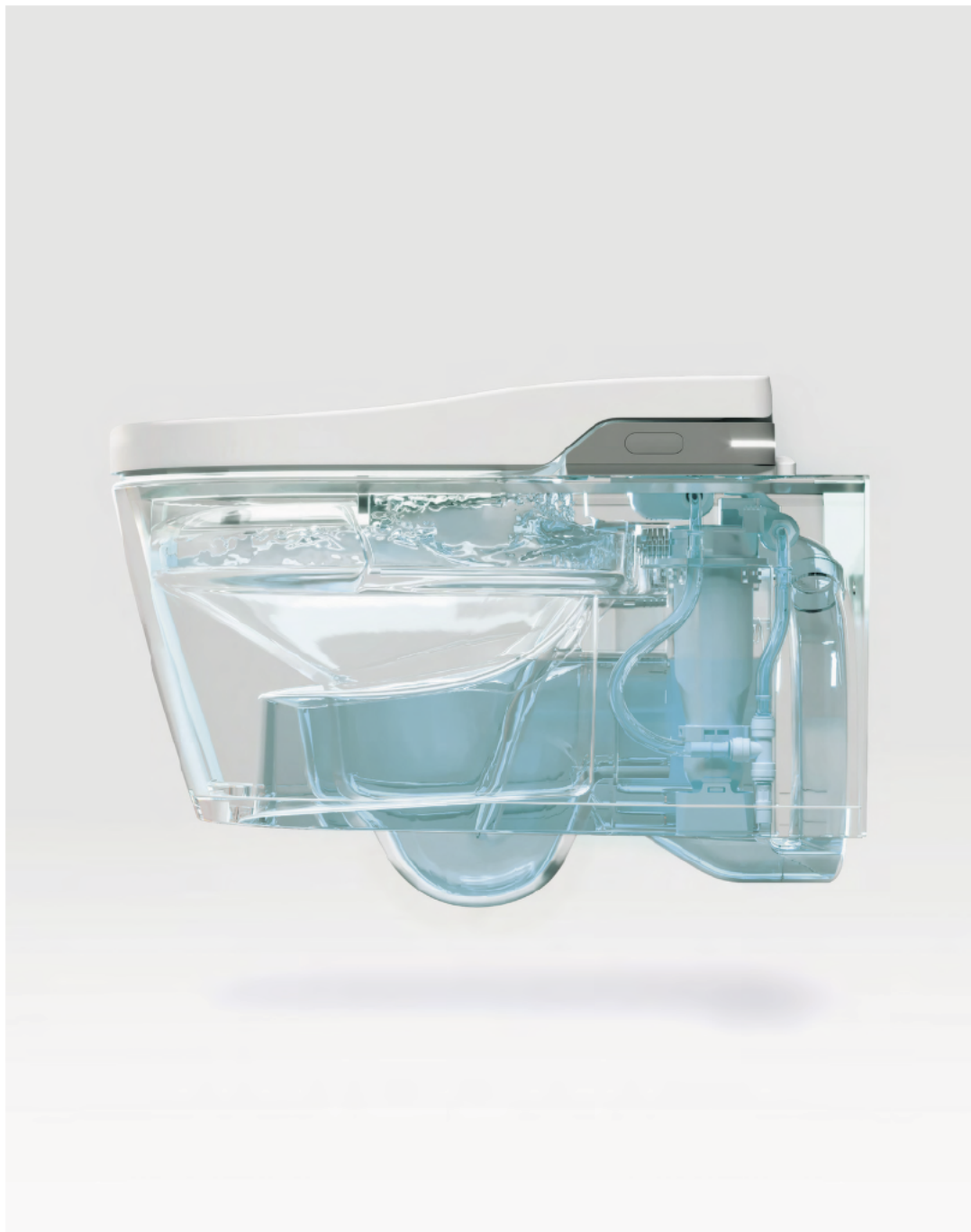

In-Wash® Inspira In-Tank®

### **In-Tank®**

A notable innovation is Roca's In-Tank® technology. This ingenious design, which integrates the cistern into the toilet bowl, significantly enhances the user experience by combining practicality with advanced technology for maximum convenience. The In-Tank. design is both space-saving and aesthetically pleasing. By eliminating the external ceramic cistern and flush plate, it frees up valuable bathroom space while maintaining clean, sleek lines that contribute to a modern and visually appealing look. Placing all the necessary elements in the toilet bowl and off the wall also ensures easier access, installation and maintenance.

In-Tank® offers a 4.5 litre full flush that combines powerful performance with quiet operation. Unlike traditional systems where water is stored behind the wall, In-Tank's integrated design ensures reduced noise levels, without disturbing adjacent rooms.

## Seamless automation

A presence sensor enables the automation of various functions, all of which can be easily configured through the Roca Connect app. These functions are activated as the user approaches, ensuring a seamless and convenient experience:

### **Auto Open/Close**

The automatic opening and closing of the seat and lid provides a more hygienic and comfortable experience, eliminating the need to touch the seat or lid.

### **Auto Flush**

This feature automatically determines the appropriate flush volume, providing either a full or half flush, depending on user needs. For added hygiene and convenience, this functionality also allows the configuration of a pre-flush that activates as the user approaches, helping to maintain a clean bowl.



Auto open Close In-Wash® Insignia



Auto Flush In-Wash® Insignia



In-Wash® Insignia night light

### **Auto Deodoriser**

Designed to effectively remove odours and maintain a fresh bathroom environment, the automatic deodoriser uses an advanced design to maximise odour removal efficiency. To ensure that all odours are effectively neutralised, three key factors are maximised:

1. The contact time between the contaminated air and the carbon filter
2. The size of the filter to increase the contact area
3. The choice of a high quality, easily replaceable carbon filter with exceptional absorption capacity

### **Night Light**

For convenient nighttime visits, the night light provides subtle illumination, with options for manual, scheduled or automatic activation.

## A new standard of bathroom cleanliness

Beyond personal care, smart toilets offer cutting-edge features that ensure unparalleled bathroom hygiene and freshness to ensure a pristine bathroom with minimal effort.

### Hygiene Flush

Roca's signature Hygiene Flush provides comprehensive cleaning and a subtle infusion of freshness through a dose of aromas released with each flush.

### Roca Rimless® Vortex

This innovative design, which replaces the traditional rim of the toilet bowl with a smooth edge, allows water to flow around the edge of the bowl during flushing, rather than from the inside of the rim. This makes it easier to clean and more hygienic, eliminating the nooks and crannies where dirt and bacteria typically accumulate.



Hygiene Flush In-Wash® Insignia

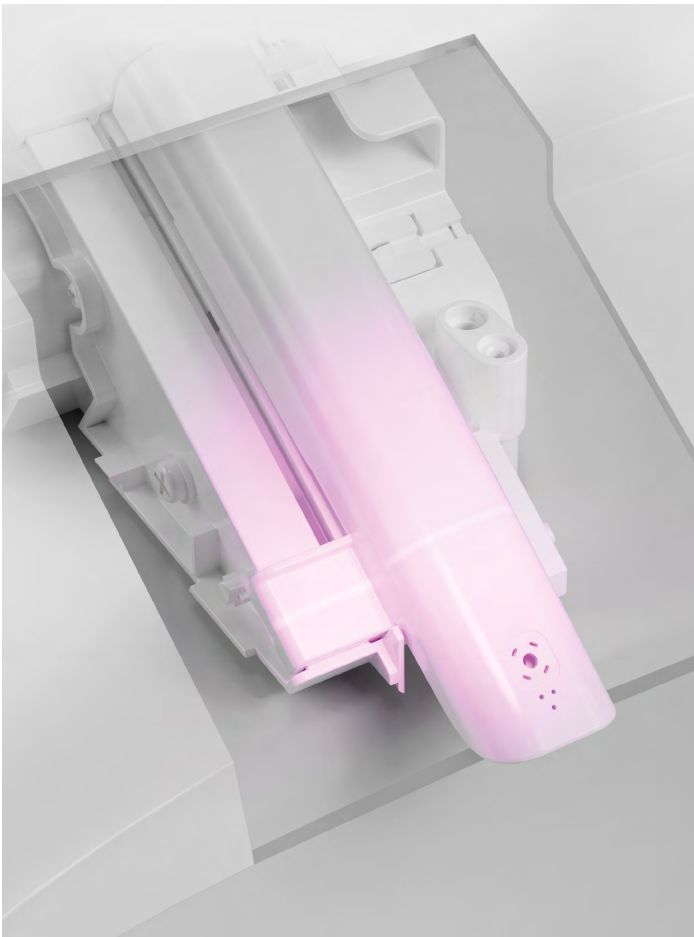

UV Light Desinfection In-Wash® Ona, In-Wash® The Gap and Multiclean® M4



Lift & Clean In-Wash® Ona, In-Wash® The Gap and Multiclean® M4

### **Self-cleaning nozzle with UV**

The application of water before and after each use, supplemented by UV light, effectively removes 99.99% of bacteria. While water cleaning alone is sufficient, integrated UV light treatment ensures optimum nozzle disinfection.

### **Supraglaze®**

An exclusive smooth Roca glazing for the bowl allows easy removal of any dirt particles and bacteria for greater hygiene.

### **Lift&Clean**

Combined with Roca Rimless® technology, Lift&Clean makes it easy to remove all dirt particles, improving toilet hygiene and streamlining the cleaning process. The e-bidet can be partially detached, allowing the user to reach anywhere easily for cleaning.

### **Descaling**

Designed for easy maintenance and extended performance, the descaling solution is easy to use and requires minimal effort. Conveniently accessible via Roca Connect within the alerts and application support framework.

# The connected experience

Roca Connect

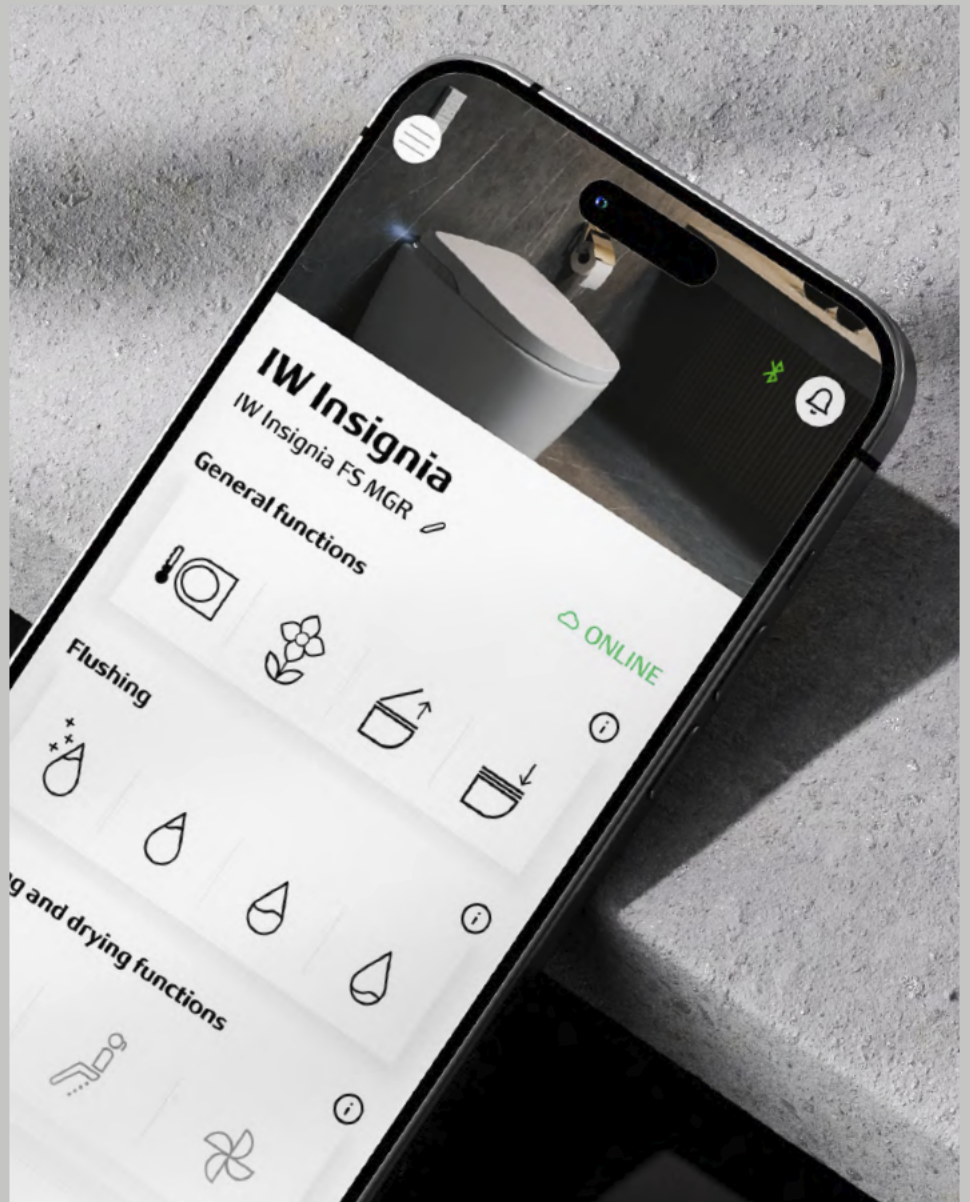

Roca Connect brings smart technology to the bathroom and enhances daily life. Designed as an easy-to-use extension of the remote control, the Roca Connect app allows users to effortlessly manage a myriad of functions, providing unparalleled convenience.

Users can set cleaning routines and schedule specific convenience settings, as well as customise washing and drying preferences and adjust automatic functions. In addition, users can check product status and conveniently purchase In-Wash® consumables via the app, including the Hygiene Flush liquid, which makes cleaning easier and adds hygiene to the flush, descaling agents and a deodorising active carbon filter.

The capabilities of the IoT go far beyond managing toilet functions. Roca Connect serves as a comprehensive solution for better water management, providing real-time data and insights to optimise consumption. Through its intuitive dashboard or mobile app, users can monitor water usage, receive alerts, and predict behaviour, to ensure a sustainable approach to water use.

Whether it's setting periodic self-cleaning functions or accessing usage insights, Roca Connect empowers users to make informed decisions and actively contribute to a more sustainable future. In essence, Roca Connect embodies the convergence of technology and sustainability, transforming the bathroom experience into one that is not only convenient but also environmentally conscious.

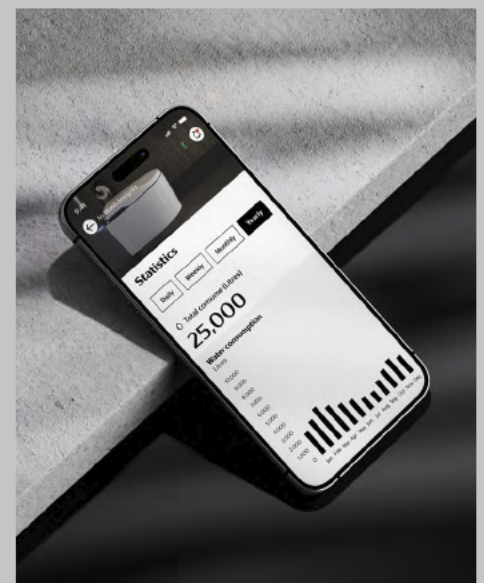
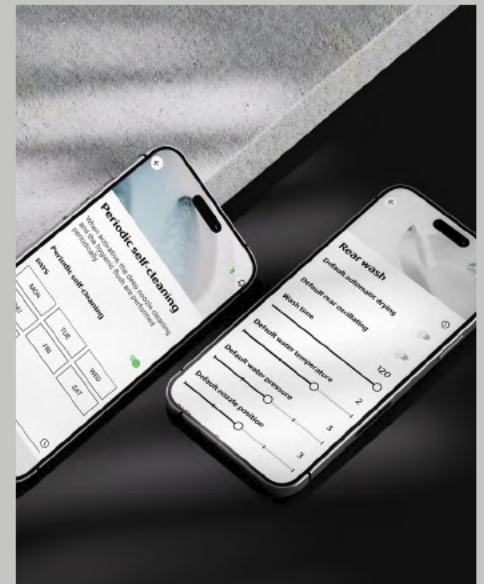



# In-Wash®

**Roca's new generation of In-Wash® smart toilets provide the utmost cleanliness, hygiene, and intimate care. They offer a range of options to suit different preferences and budgets, combining cutting-edge technology, hygiene and comfort to offer users a modern and connected bathroom experience. With intuitive elements, and exclusive Roca systems, they consistently maintain high levels of cleanliness.**

# The Ultimate Smart Toilet

Roca's In-Wash® Insignia is designed to provide the ultimate bathroom experience. Crafted for those who seek the pinnacle of innovation, In-Wash® Insignia sets a new standard in the digitalization of bathroom routines, combining cutting-edge technology with Roca's commitment to quality.

This high-end smart toilet boasts state-of-the-art washing and drying technology, Roca's signature In-Tank® innovation and a connected toilet experience through Roca Connect. It represents a bold leap forward in the category of smart toilets, with every aspect meticulously selected, from top-notch features to materials and coatings. In-Wash® Insignia sets the benchmark for the future of bathroom digitalisation.

## In-Wash® Insignia



reddot winner 2022



# In-Wash® Insignia at a glance

## Rear Wash with Multi Stream

A choice of three different rear wash modes – soft, intense or mixed – to suit different preferences and customisable via the app.

## Soft Front Wash

Spraying from nine different sources for gentle washing.

## Coanda Effect Dryer

By directing air precisely where it is needed, this feature provides maximum drying performance at any power level.

## Roca Connect

Users can adjust process settings, schedule maintenance, and control washing and drying functions remotely, and receive useful notifications and consumption statistics.

## In-Tank®

Integrated water tank to maximise available space and unify aesthetics and practicality in the bathroom.

## Autofunctions

A presence sensor allows automation of multiple functions including opening and closing of the lid and seat, a night light, flush and deodorizer. All can be configured via the app.

## Quick Release Heated Seat

A seat that distributes heat evenly and is easy to remove for cleaning for the best experience.

## Roca Rimless® Vortex

A bowl specially designed to optimize water flow, flush performance and cleaning.

## Hygiene Flush

A signature feature by Roca that provides thorough cleaning and subtle aromatization through to a freshening dose released with every flush.

## Supraglaze®

An exclusive Roca glazing allows easy removal of any dirt particles and bacteria for greater hygiene.

## Self-Cleaning Nozzle with UV Light

Automatic self cleaning of the nozzle with water and UV light before and after each use.

## Deodorizer

A high-performance system with an active carbon filter to remove odours.

## Descaling

An easy-to-use descaling process for long-term performance.

Roca Connect

---

Autofunctions

---

Descaling

---

Self-Cleaning Nozzle with UV Light

---

Coanda Effect

---

Deodorizer

---

In-Tank®

---

Supraglaze®

---

Roca Rimless® Vortex  
Hygiene Flush

---

Quick Release Heated Seat

---

Soft Front Wash  
Rear Wash with Multi-Stream

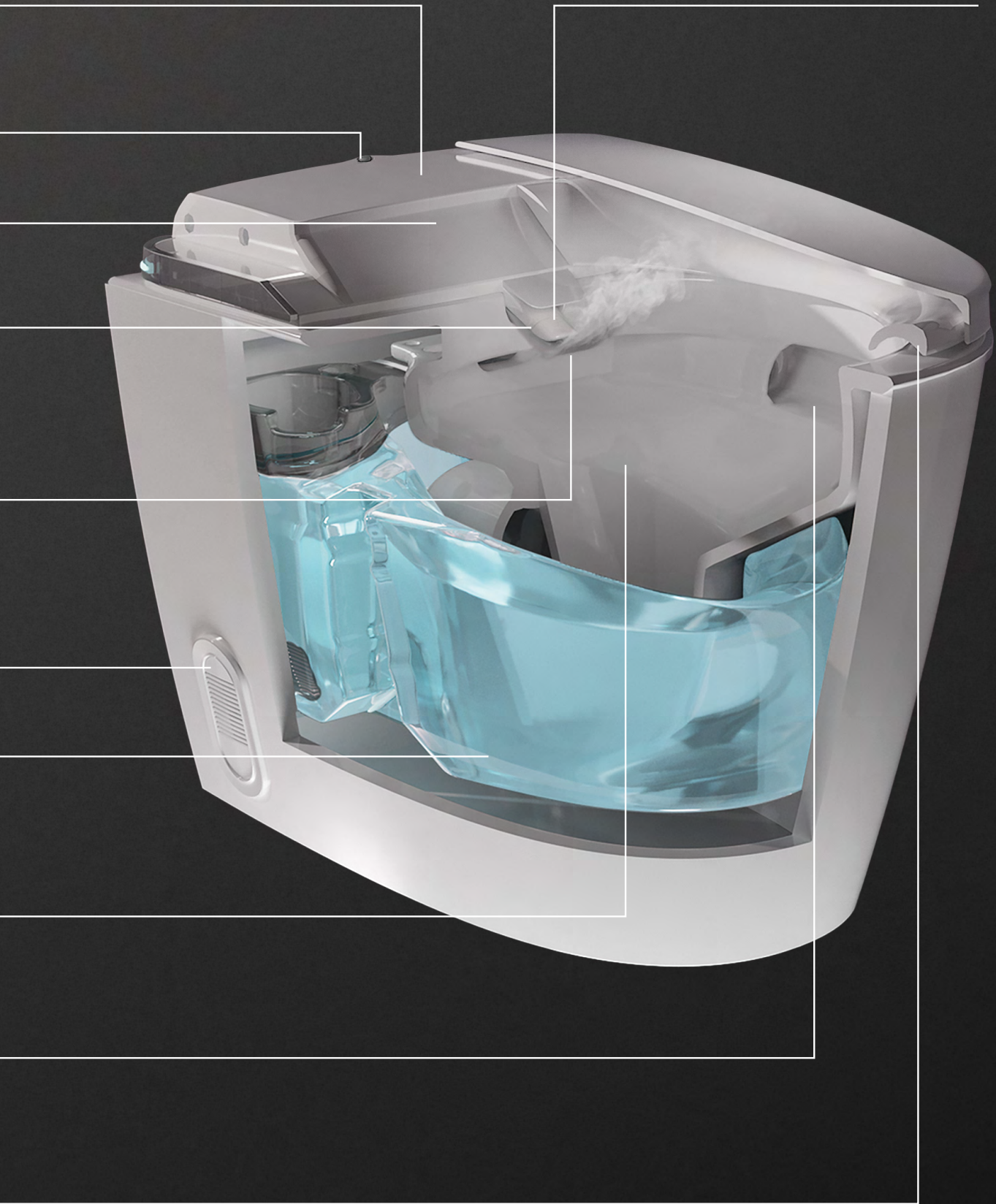



## In-Wash® Insignia wall-hung

Wall-hung smart toilet with integrated tank of Eco dual flush 4,5/3 litres. Includes Roca Rimless® Vortex, premium functions and Supraglaze® glazing. Needs power supply.  
**A803104001**

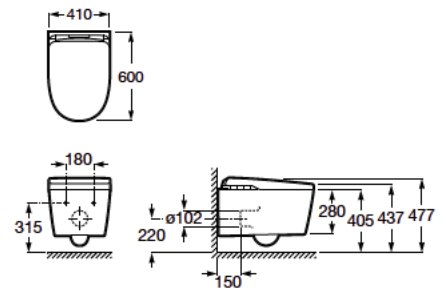

## In-Wash® back to wall floorstanding

Back to wall floorstanding smart toilet with integrated tank of Eco dual flush 4,5/3 litres. Includes Roca Rimless® Vortex, premium functions and Supraglaze® glazing. Needs power supply.  
**A803105001**

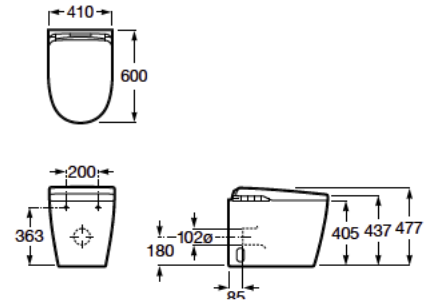

## Functionalities

Rear Wash with Multi-Stream



Soft Front Wash



Coanda Effect Dryer



In-Tank®



Roca Rimless® Vortex



Supraglaze®



Heated Seat



Hygiene Flush



Eco Dual Flush



UV Light



Automatic Open/Close

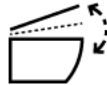

Roca Connect



Dimensions in mm.

# The Original In-Wash®

The foundation of Roca's smart toilet innovation journey, In-Wash® Inspira set the standard for all the designs that followed. Defined by a sleek and minimalist design that runs throughout the entire collection, the In-Wash® Inspira offers fully customizable and intuitive features to ensure a consistently flawless daily bathroom experience. This smart toilet features pioneering solutions tailored to meet a diverse range of needs, preferences and aspirations.

# In-Wash® Inspira





# In-Wash<sup>®</sup> Inspira at a glance

## Rear and Front Wash

Washing features with extensive customisation options including water temperature, water flow pressure, nozzle position and oscillating movement.

## Dryer

Drying function with four-level temperature control: 35°, 37°, 39 ° and ambient.

## Intuitive Panel and Remote Control

Easy to adjust the settings of each function and control the entire washing and drying experience.

## In-Tank<sup>®</sup>

Integrated water tank to maximise available space and unify aesthetics and practicality in the bathroom. Only available in the In-Tank<sup>®</sup> version.

## Night Light

Subtle illumination to easily find In-Wash<sup>®</sup> Inspira in the dark.

## User Detection

A presence sensor activates the automation of various functions.

## Quick Release

Seat and cover are easily removed for easy cleaning.

## Roca Rimless<sup>®</sup>

Interior bowl with no hidden nooks and crannies where dirt and germs can accumulate, making it easier to clean.

## Roca Rimless<sup>®</sup> Vortex

A bowl specially designed to optimise water flow, flush performance and cleaning. Only available in the In-Tank<sup>®</sup> version.

## Supraglaze<sup>®</sup>

An exclusive Roca glazing allows easy removal of any dirt particles and bacteria for greater hygiene. Only available in the In-Tank<sup>®</sup> version.

## Self-Cleaning Nozzle

Applying water before and after every use.

Quick Release

---

User Detection

---

Night Light

---

Intuitive Panel and Remote Control

---

Dryer

---

In-Tank<sup>®</sup>

---

Supraglaze<sup>®</sup>

---

Roca Rimless<sup>®</sup> Vortex  
Roca Rimless<sup>®</sup>

---

Rear and Front Wash  
Self-Cleaning Nozzle

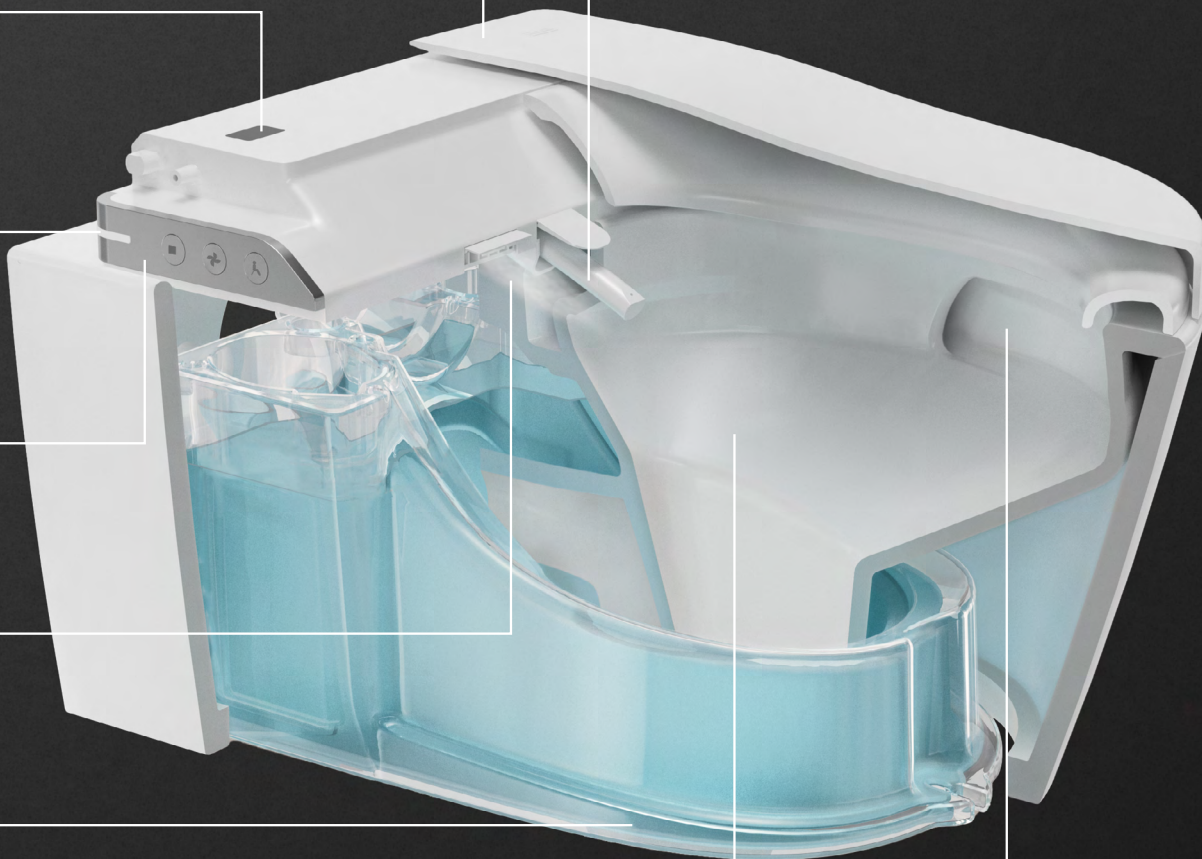



# In-Wash® Inspira

## In-Wash® Inspira with In-Tank® wall-hung

Wall-hung smart toilet with integrated Eco Dual flush 4.5/3 litres tank. Includes Roca Rimless® Vortex, seat and cover with washing and drying function. Supraglaze® glazing. Needs power supply.  
**A803094001**

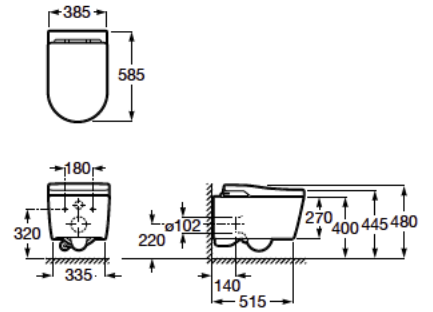

## In-Wash® Inspira with In-Tank® back to wall single floorstanding

Back to wall single floorstanding smart toilet with integrated Eco Dual flush 4.5/3 litres tank and dual outlet. Includes Roca Rimless® Vortex, seat and cover with washing and drying function. Supraglaze® glazing. Needs power supply.  
**A803095001**

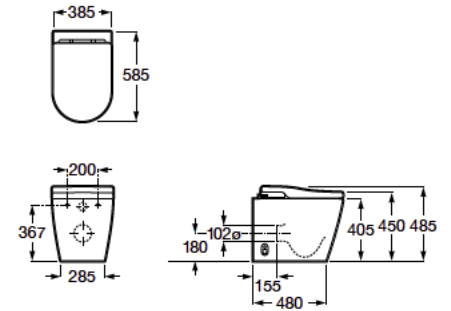

## Functionalities

Rear Wash



Front Wash



Dryer



In-Tank®



Roca Rimless® Vortex



Flush



Supraglaze®



Soft Close



## In-Wash® Inspira wall-hung

Wall-hung smart toilet. Includes Roca Rimless®, seat and cover with washing and drying function. Needs power supply.  
**A803060001**

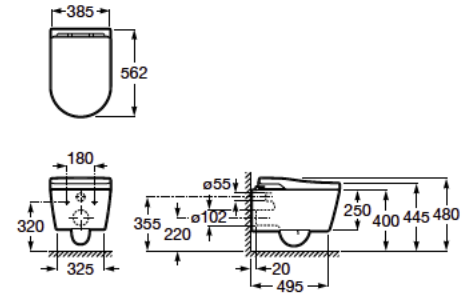

## In-Wash® Inspira back to wall single floorstanding

Back to wall single floorstanding smart toilet with dual outlet. Includes Roca Rimless®, seat and cover with washing and drying function. Needs power supply.  
**A803063001**

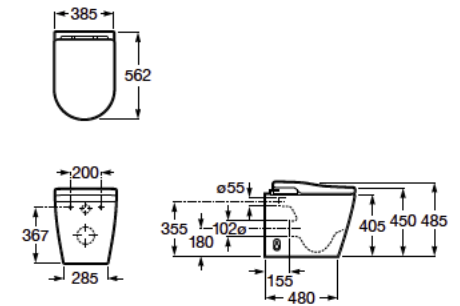

## In-Wash® Inspira back to wall close-coupled

Back to wall close-coupled smart toilet with dual flush 4.5/3 litres and dual outlet. Includes Roca Rimless®, seat and cover with washing and drying function. Needs power supply.  
**A80306L001**

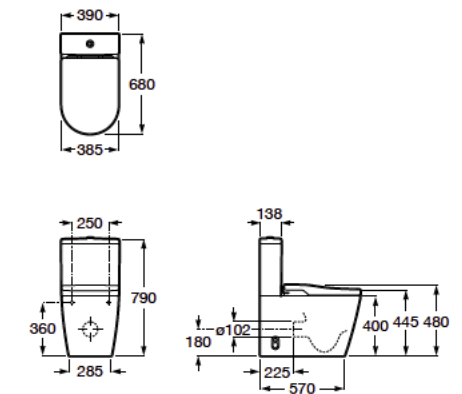

## Functionalities

Rear Wash



Front Wash



Dryer



Roca Rimless®



Flush



Soft Close



Dimensions in mm.



## Smart made simple

Drawing inspiration from the beauty of Mediterranean nature, In-Wash® Ona aims to capture that precise and serene moment when everything happens at the right time and in a completely intuitive way. The synergy of technology and design enriches this experience, creating a sense of simplicity and peace of mind. In-Wash® Ona is not just an ordinary smart toilet; it is smart made simple.

# In-Wash® Ona





# In-Wash<sup>®</sup> Ona at a glance

## Rear and Front Wash with Airtech Technology

Airtech technology is used, where air is mixed into the water for a better cleaning result. Fully customisable with adaptable water temperature, nozzle position and water pressure.

## Coanda Effect Dryer

By directing air precisely where it is needed, this feature provides maximum drying performance at any power level.

## Knob and Side Panel

A control knob and side panel offer easy and accessible control of the entire washing and drying experience.

## Roca Connect

Users can adjust process settings, schedule maintenance, and control washing and drying functions remotely, and receive useful notifications and consumption statistics.

## Heated Seat

An optional feature that distributes heat evenly throughout the seat. Only available in heated seat versions.

## Night Light

Subtle lighting makes it easy to navigate in the dark.

## Roca Rimless<sup>®</sup>

Interior bowl with no hidden nooks and crannies where dirt and germs can accumulate, making it easier to clean.

## Supraglaze<sup>®</sup>

An exclusive Roca glazing allows easy removal of any dirt particles and bacteria for greater hygiene.

## Self-Cleaning Nozzle with UV Light

Automatic self-cleaning of the nozzle with water and UV light before and after each use.

## Lift&Clean

The e-bidet can be partially detached. A simple lift to make cleaning extra easy.

## Descaling

An easy-to-use descaling process to ensure long-term performance.

Lift&Clean

---

Roca Connect

---

Descaling

---

Knob and Side Panel

---

Night Light

---

Self-Cleaning Nozzle with UV Light

---

Coanda Effect

---

Roca Rimless<sup>®</sup>

---

Heated Seat

---

Rear Wash with Airtech Technology  
Front Wash



In-Wash® Ona wall-hung

Wall-hung smart toilet. Roca Rimless®, seat and cover with washing and drying function included. Needs power supply. **A803150S01**

Heated seat with adjustable temperature. **A80315FS01**

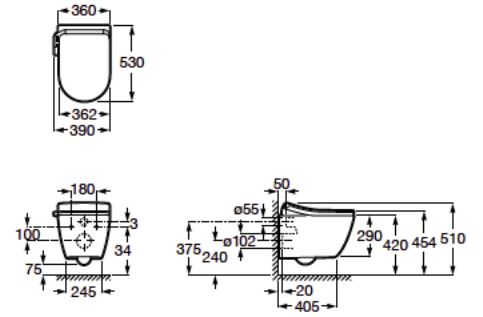

## In-Wash® Ona back to wall single floorstanding

Back to wall single floorstanding smart toilet with dual outlet. Roca Rimless®, seat and cover with washing and drying function included. Needs power supply.  
**A803153S01**

Heated seat with adjustable temperature.  
**A80315FS01**

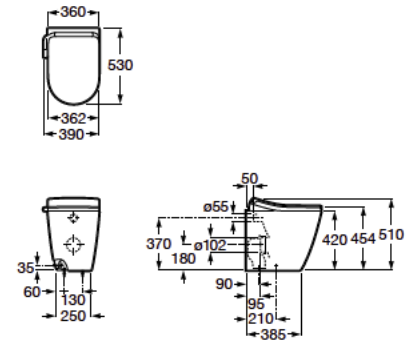

## In-Wash® Ona back to wall compact close-coupled

Back to wall compact close-coupled smart toilet with Eco Dual flush 4,5/3 litre and dual outlet. Roca Rimless®, seat and cover washing and drying function included. Needs power supply.  
**A803461S01**

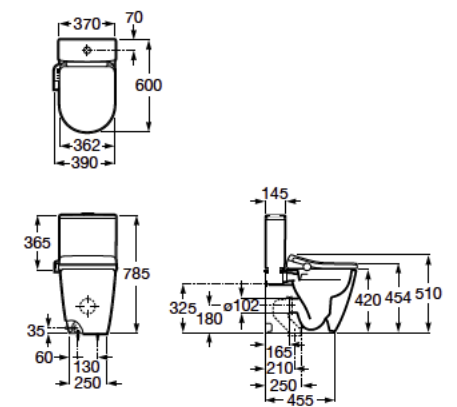

## In-Wash® Ona close-coupled

Close-coupled smart toilet with dual flush 4,5/3 litre and Eco Dual outlet. Roca Rimless®, seat and cover washing and drying function included. Needs power supply.  
**A803151S01**

Heated seat with adjustable temperature.  
**A80315FS01**

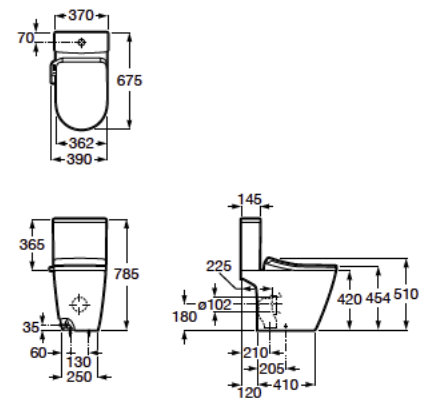

## Functionalities

Rear Wash with Airtech



Front Wash



Coanda Effect



Roca Rimless®



Roca Connect

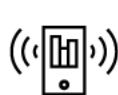

Flush



UV Light



Soft Close



Heated Seat\*



Dimensions in mm. \*Available in A80315FS01

## Smartly Versatile

Inspired by the popular The Gap collection, this smart toilet seamlessly integrates iconic design elements with intelligent toilet technology. With a focus on versatility, sustainability and contemporary aesthetics, In-Wash® The Gap reflects meticulous attention to detail, offering enhanced hygiene and user-friendly features without compromising on style. The very essence of adaptability, reliability and modern practicality, In-Wash® The Gap offers a wealth of customisation options.

# In-Wash® The Gap





# In-Wash® The Gap at a glance

## Rear and Front Wash with Airtech Technology

Airtech technology is used, where air is mixed into the water for a better cleaning result. Fully customisable with adaptable water temperature, nozzle position and water pressure.

## Coanda Effect Dryer

By directing air precisely where it is needed, this feature provides maximum drying performance at any power level.

## Knob and Side Panel

A control knob and side panel offer easy and accessible control of the entire washing and drying experience.

## Roca Connect

Users can adjust process settings, schedule maintenance, and control washing and drying functions remotely, and receive useful notifications and consumption statistics.

## Heated Seat

An optional feature that distributes heat evenly throughout the seat. Only available in heated seat versions.

## Night Light

Subtle lighting makes it easy to navigate in the dark.

## Roca Rimless®

Interior bowl with no hidden nooks and crannies where dirt and germs can accumulate, making it easier to clean.

## Supraglaze®

An exclusive Roca glazing allows easy removal of any dirt particles and bacteria for greater hygiene.

## Self-Cleaning Nozzle with UV Light

Automatic self-cleaning of the nozzle with water and UV light before and after each use.

## Lift&Clean

The e-bidet can be partially detached. A simple lift to make cleaning extra easy.

## Descaling

An easy-to-use descaling process to ensure long-term performance.

Lift&Clean

---

Roca Connect

---

Descaling

---

Knob and Side Panel

---

Night Light

---

Self-Cleaning Nozzle with UV Light

---

Coanda Effect

---

Roca Rimless®

---

Heated Seat

---

Rear and Front Wash





# In-Wash® The Gap

## In-Wash® The Gap wall-hung

Wall-hung smart toilet. Roca Rimless®, seat and cover with washing and drying function included. Needs power supply.  
**A803180001**

Heated seat with adjustable temperature.  
**A80318F001**

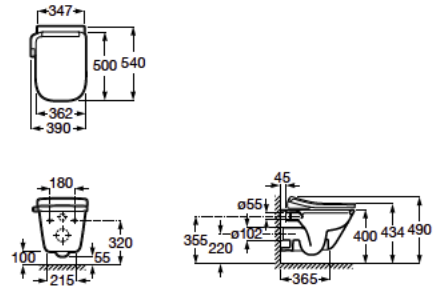

## In-Wash® The Gap Back to wall compact close-coupled

Back to wall compact close-coupled smart toilet with Eco Dual flush 4,5/3 litre and dual outlet. Roca Rimless®, seat and cover with washing and drying function included. Needs power supply.  
**A803421001**

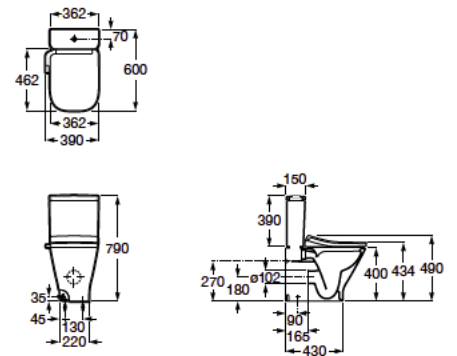

## In-Wash® The Gap close-coupled

Close-coupled smart toilet with dual flush 4,5/3 litre and Eco Dual outlet. Roca Rimless®, seat and cover washing and drying function included. Needs power supply.  
**A803181001**

Heated seat with adjustable temperature.  
**A80318H001**

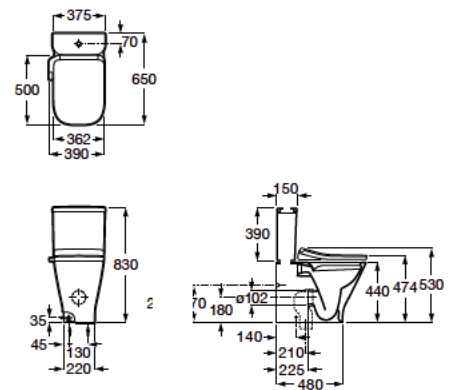

## Functionalities

Rear Wash with Airtech



Front Wash



Coanda Effect



Roca Rimless®



Roca Connect

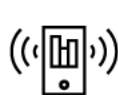

Flush



UV Light



Soft Close



Heated Seat\*



Dimensions in mm. \*Available in A80318H001



# Multiclean® M-Series

Integrating seamlessly with most of Roca's existing toilets, the Multiclean® M-Series offers a new level of comfort and cleanliness with advanced cleaning capabilities and smart technology. Designed with aesthetics and user needs in mind, the Multiclean® seats allow households of all types to enjoy the benefits of shower toilets or smart toilets with upgrades that transform the traditional toilet experience into something much more sophisticated.

# Today's Technology, for Everyone

The Multiclean® M4 harnesses the power of technology to transform a standard toilet into a smart one. With its sleek design and IoT, this fully configurable smart toilet offers state-of-the-art washing and drying technology, as well as various features that enhance comfort and simplify cleaning and maintenance.

## Multiclean® M4





## Cleaning in total comfort

The Multiclean® M3 enhances bathroom comfort and hygiene with its easy installation and elegant design. Featuring rear and front washing with warm water at 37°C, it transforms a regular toilet into a hot water shower toilet; a simple and seamless addition that puts comfort within reach of many.

# Multiclean® M3





## The simple and hassle-free solution

The Multiclean® M1 is the simplest solution with the easiest installation. With both rear and front washing options, it offers a simple way to convert a conventional toilet into a shower toilet without the need for a power source. A durable and affordable upgrade for any household.

# Multiclean® M1





**Multiclean® M4 Round**

Smart seat with washing and drying function.  
Round shape.  
Needs power supply.  
**A804054001**

Heated seat with adjustable temperature.  
**A804054S01**

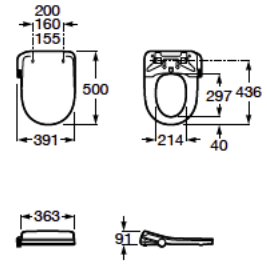

**Multiclean® M4 Round Compact**

Smart seat with washing and drying function.  
Round shape.  
Needs power supply.  
**A804057001**

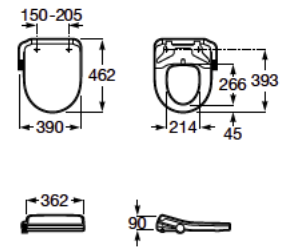

**Multiclean® M4 Square**

Smart seat with washing and drying function.  
Square shape.  
Needs power supply.  
**A804054021**

Heated seat with adjustable temperature.  
**A804054S21**

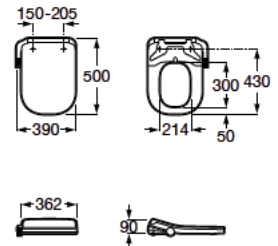

**Multiclean® M4 Square Compact**

Smart seat with washing and drying function.  
Square shape.  
Needs power supply.  
**A804057021**

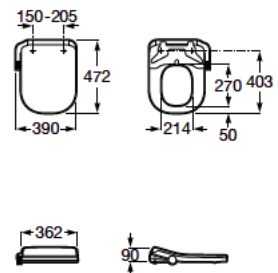

**Functionalities**

Front Wash



Rear Wash



Soft Close



UV Light



Coanda Effect



Roca Connect

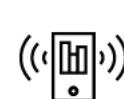

Heated Seat



Dimensions in mm.

A804054S01, A804054S21

**Multiclean® M3**

Shower toilet with washing function at water inlet temperature or 37°C. Round shape. Needs power supply. **A804052001**

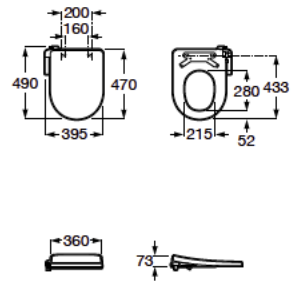

**Multiclean® M1**

Shower toilet with washing function at water inlet temperature. Round shape. **A80405200H**

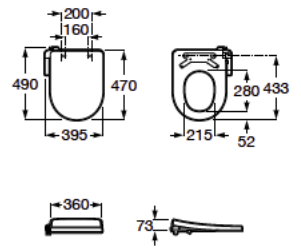

**Functionalities**

Front Wash



Rear Wash







































Soft Close



Dimensions in mm.

# Multiclean® Compatibility

Collection / Reference		Multiclean® M4	Multiclean® M3/M1
Access	<b>Close-coupled floorstanding</b>		
	A342236..0		•
	A342239..0		•
	A342237..0		•
	<b>700 mm Wall-hung</b>		
	A346237.0		•
	<b>Wall-hung</b>		
A346236..0		•	
Carmen	<b>Close-coupled floorstanding</b>		
	A3420A7.0		•
	<b>Single floorstanding</b>		
A3440A9..0		•	
Happening	<b>Single floorstanding</b>		
	A347567.0		•
	<b>Wall-hung</b>		
A346567.0		•	
Meridian	<b>Single floorstanding</b>		
	A347247.0		•
	A347246..0		•
	<b>Reduced mobility</b>		
	A34224H..0		•
	<b>560 mm Wall-hung</b>		
	A346247.0		•
	A34624L..0		•
	<b>Close-coupled floorstanding</b>		
A342245..0		•	
Dama Retro	<b>Close-coupled floorstanding</b>		
	A342321..1		•
	A342320..1		•
Ona	<b>Close-coupled floorstanding</b>		
	A342687.0		•
	<b>Single floorstanding</b>		
	A347687.0		•
	<b>Wall-hung</b>		
A346687.0		•	

Collection / Reference		Multiclean® M4	Multiclean® M3/M1
The Gap Round	<b>Close-coupled floorstanding</b>		
	A3420N8..0		•
	<b>Single floorstanding</b>		
	A3470N7.0		•
	A3470N8..0		•
	<b>Wall-hung</b>		
A3460NL.0		•	
The Gap Round D-Trit	<b>Close-coupled floorstanding</b>		
	A34T0N2..0		•
Debba Round	<b>Close-coupled floorstanding</b>		
	A34299P.0		•
	A34299J..0		•
	A34299K..0		•
	<b>Wall-hung</b>		
A346998..0		•	
Giraldia	<b>Close-coupled floorstanding</b>		
	A342464..0		•
	A342463..0		•
Victoria	<b>Close-coupled floorstanding</b>		
	A342394..0		•
	A342395..0		•
	A34239S..0		•
	<b>Single floorstanding</b>		
	A344398..0		•
	A344397..0		•
	<b>Wall-hung</b>		
A346303..S		•	

We understand that solutions like Multiclean® M-Series must be both aesthetic, practical, and easy to install. So, our team of designers and engineers went the extra mile to guarantee that the new Multiclean® range fits into most of the Roca toilet range.

# Quick Guide

IW Insignia

IW Inspira with In-Tank®

IW Inspira

IW Ona

IW The Gap



	IW Insignia	IW Inspira with In-Tank®	IW Inspira	IW Ona	IW The Gap
Washing & Drying	Rear wash	•	•	•	•
	Rear wash with Multi-stream function (3 modes)	•			
	Front wash	•	•	•	•
	Soft front wash	•			
	Oscillating wash	•	•	•	•
	Water heating	•	•	•	•
	Water temperature control	•	•	•	•
	Water pressure control	•	•	•	•
	Nozzle position adjustment	•	•	•	•
	Drying function	•	•	•	•
	Dryer Intensity control	•			•
	Coanda Effect dryer function	•			•
	Comfort	Soft-closing seat and cover	•	•	•
Heated Seat		•			*
Automatic Open/Close		•			
Automatic flush system		•			
Pre Flush system		•			
In-tank		•	•		
Remote control		•	•	•	
Side control panel		•	•	•	•
Roca Connect		•			•
Customized programs		•			•
User detection		•	•	•	•
Night light		•	•	•	•
Stand-by mode		•	•	•	•
Hidden water and power supply	•	•	•	•	
Hygiene	Self-cleaning nozzle	•	•	•	•
	Automatic nozzle cleaning	•	•	•	•
	Self-cleaning nozzle with UV Light	•			•
	Removable nozzle tip	•	•	•	•
	Quick release seat	•	•	•	
	Quick release cover	•	•	•	•
	Roca Rimless® technology	•	•	•	•
	Vortex technology	•	•		
	Hygiene flush	•			
	Supraglaze® glazing	•	•		•
	Deodorizer function	•			
Descaling	•			•	

All products comply with the EN1717 regulation

\* Available in Heated Seat versions



		M4	M3	M1
Washing & Drying	Rear wash	•	•	•
	Rear wash with Multi-stream function (3 modes)			
	Front wash	•	•	•
	Soft front wash			
	Oscillating wash	•		
	Water heating	•	•	
	Water temperature control	•		
	Water pressure control	•		
	Nozzle position adjustment	•		
	Drying function	•		
	Dryer intensity control	•		
	Coanda Effect dryer function	•		
	Comfort	Soft-closing seat and cover	•	•
Heated Seat		*		
Automatic Open/Close				
Automatic flush system				
Pre Flush system				
In-tank				
Remote control				
Side control panel		•	•	•
Roca Connect		•		
Customized programs		•		
User detection		•		
Night light		•		
Stand-by mode		•		
Hidden water and power supply	•			
Hygiene	Self-cleaning nozzle	•	•	•
	Automatic nozzle cleaning	•		
	Self-cleaning nozzle with UV Light	•		
	Removable nozzle tip	•		
	Quick release seat		•	•
	Quick release cover	•	•	•
	Roca Rimless® technology	•		
	Vortex technology			
	Hygiene flush			
	Supraglaze® glazing	•		
	Deodorizer function			
	Descaling	•		

All products comply with the EN1717 regulation

\* Available in Heated Seat versions

**Barcelona**  
**Since 1917**  
**79 Production facilities**  
**5 Continents**  
**21,000 People**  
**170 Markets**



Roca is a family-owned company dedicated to the design and production of solutions for the bathroom space. From our beginnings in Barcelona in 1917, we have grown into a global benchmark in sanitaryware. Roca is now one of the largest producers of bathroom products on the planet, operating 76 production facilities across five continents, employing over 21,000 people and serving over 170 markets.



Our proposals are characterised by Mediterranean-inspired aesthetics, a diverse range that can be adapted to any space, and the inclusion of water and energy-saving solutions. This is complemented by the latest technological advances in connectivity, safety and comfort, as well as new materials and finishes.

Our commitment to the planet extends into the social field. We are serious about our responsibility towards our employees and the communities we serve, aiming to improve people's lives both within and outside the company. To achieve this, we carry out a wide range of activities around the world to stay in close contact with our valued customers and users. Two of the most popular and widely recognised international initiatives are the Roca One Day Design Challenge competition, which encourages and showcases the skills of up-and-coming creatives, and our network of Roca Galleries. These galleries host events and exhibitions that allow us to maintain an ongoing conversation with the community. We recently opened a new location in São Paulo, the first Roca Gallery in the Americas. The [rocagallery.com](https://rocagallery.com) platform further encourages reflection and discussion by presenting monographic themes with contributions from esteemed writers.

As a global company, we are present at events of international importance, sharing the values of innovation, sustainability, teamwork, and looking to the future. In 2024, we look forward to our participation in the Salone del Mobile in Milan a global event for exploring new trends in architecture and design. We will also be present at the sector's leading trade fairs, including Expo Revestir in São Paulo, KBC in Shanghai, and BDNY in New York. In the world of sport, we will once again be an official sponsor at the Shanghai Tennis Masters and will be involved with Alinghi Red Bull Racing in the 37<sup>th</sup> edition of the America's Cup in Barcelona.



# We make people live the best bathroom experience

# Our contribution to a more sustainable future for all

Our commitment to sustainable growth and development prioritises the wellbeing of people and the planet. This commitment is reflected in our efforts to foster strong societal relationships and support communities, as well as initiatives in decarbonisation, eco-design and circularity. We create high-quality, durable products by considering their entire lifecycle, from carefully selected materials to optimised transport methods. Our aim is to combine the needs of society with environmental responsibility to deliver solutions that benefit everyone.

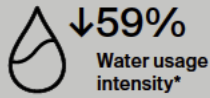
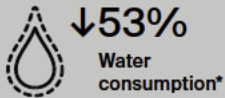
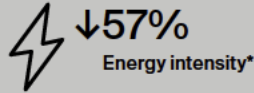
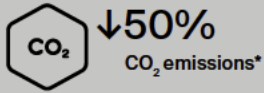

## Products

**Dual-flush mechanism.** Dual flush cisterns offer adaptable water use, ensuring efficiency for different flushing requirements while reducing overall water consumption.

**Smart shower.** Smart shower solutions allow programmable shower options and monitor water usage to encourage responsible and sustainable use.

**W+W.** Integrating the washbasin and toilet into a single piece, this internationally acclaimed design reuses water from the washbasin to flush the toilet.

**Certificates.** Many of our products are made from FSC®-certified wood.

Our water-using products carry the Unified Water Label water efficiency labelling system to help consumers understand the water and energy use in these products.



## Technologies

**Cold Start.** Cold Start technology prevents unnecessary boiler activation by defaulting to a cold water start position. This innovation saves energy and reduces emissions released into the atmosphere.

**Aerators.** Faucet spouts with aerators that mix air with water help to reduce the flow rate while maintaining the same functionality and comfort.

**Thermostatic faucets and fittings.** Quick Reaction® technology delivers desired temperatures rapidly and an eco-stop button contribute to water conservation in showers.

## Materials

**Stonex®.** An improved formula for Stonex® baths uses recycled PET bottles, reducing the carbon footprint by up to 25%.

## Initiatives

### Pioneering sustainable ceramics

Our recent partnership with Keramischer Ofenbau marks a significant step towards sustainability as we launched the world's first electric tunnel kiln for the production of sanitaryware. This pioneering initiative positions us as a global leader in the operation of a net-zero sanitaryware manufacturing facility, setting a new standard for the industry. Through collaboration and innovative technology, we aim to lead the way to a sustainable future for the ceramics industry.

## We Are Water

For over a decade, the We Are Water Foundation has promoted global hygiene and sustainable water management, improving access to clean water and sanitation in disadvantaged regions while raising awareness and providing training.

## Commitment

### Sustainable and Ethical Commitment

Roca Group is committed to implementing responsible business practices that prioritise environmental protection, social responsibility and ethical behaviour.



**EcoVadis Gold Medal** recognises Roca Group's outstanding sustainability performance.



As a proud member of the **United Nations Global Compact**, sustainability forms an integral part of our commitment and we work in line with the targets of the **Sustainable Development Goals**.

\* Data from 2018-2023  
\*\* Data from 2023



**Roca**



OFFICIAL SPONSOR

---

© Roca Sanitario S.A.U. Barcelona 2024  
Av. Diagonal, 513 / 08029 Barcelona - Spain

As part of its product development policy, Roca reserves the right to modify at any time and without prior notice, any of the models and elements described in this document; Roca therefore does not guarantee the availability of those products nor does it ensure that the specifications, colors, shapes and other reproduced features are identical to the real ones. The displayed settings are merely decorative, and no technical requirements have been taken into consideration while composing them. Total or partial reproduction of the content of this publication without Roca's express authorization is prohibited. Not all products are available in all countries.

roca.com

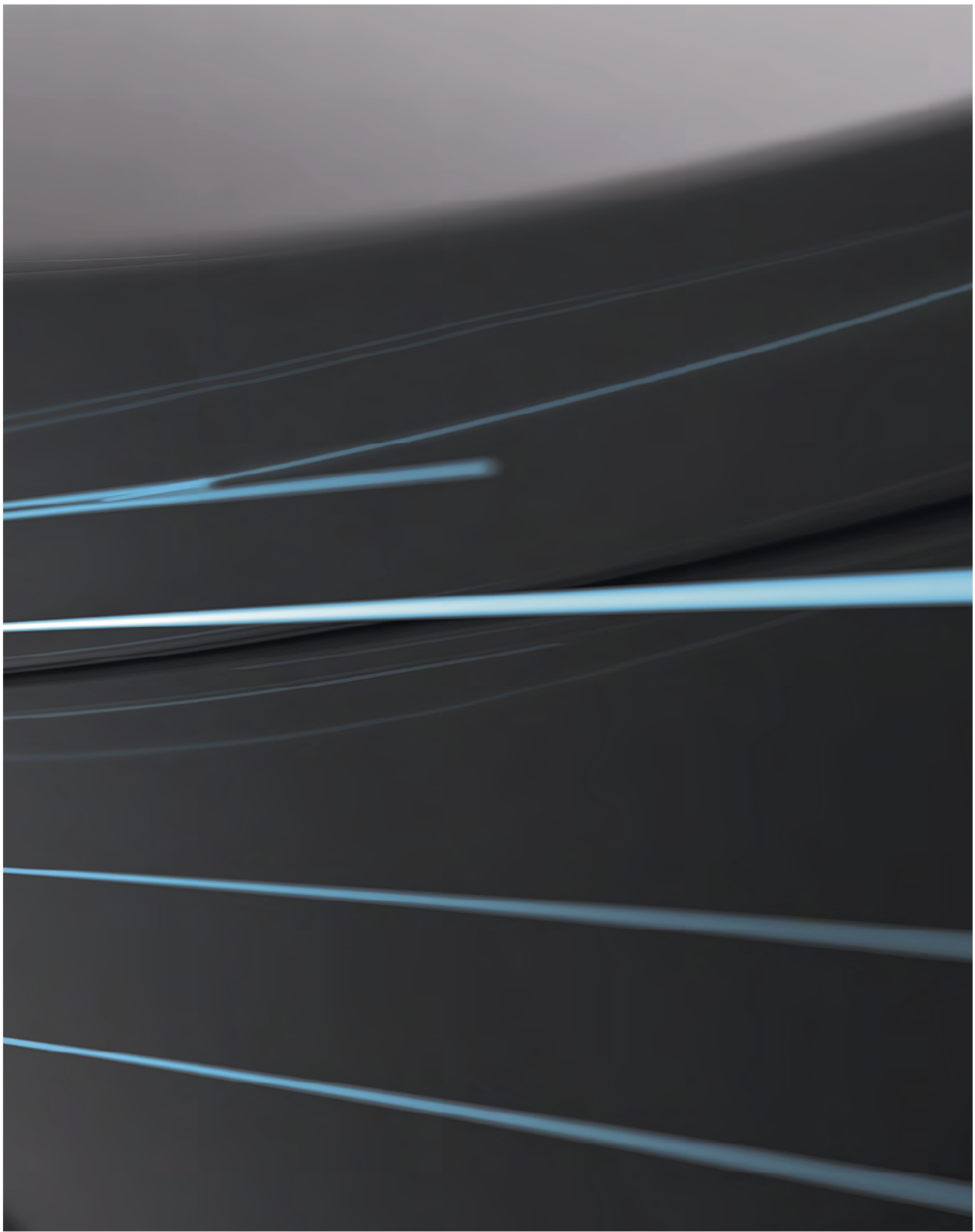

 @roca\_global

 @roca\_global

 @rocaglobal

 @roca

 @roca