

# Installation Systems

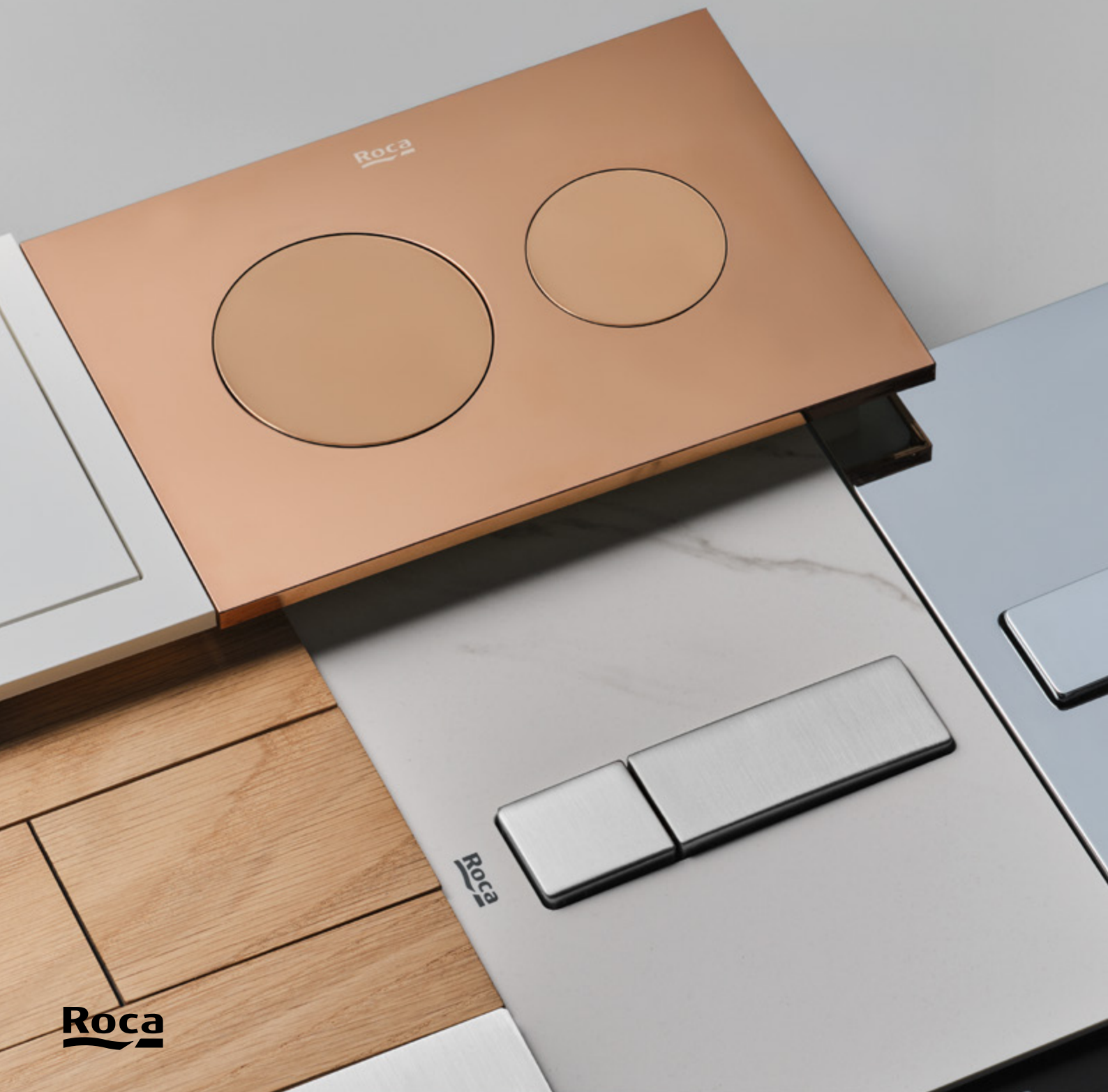



Roca



Roca

# A World of Design Options

**Roca's installation systems category brings together innovation, versatility and aesthetic refinement to elevate the modern bathroom experience. Designed to support a wide range of styles and requirements, Roca offers both the Duplo S and Duplo One systems, compatible with an extensive selection of wall-hung and floorstanding toilets, including smart toilets. Whether for renovation or new-build projects, these solutions offer easy installation, compact formats and exceptional reliability.**

**At the heart of this offer are the PS and PL flush plate collections – distinct in design yet united in purpose. While PS plates highlight contemporary style and advanced cable actuation technology, PL plates feature mechanical operation and a more traditional look. Both ranges are available in a variety of finishes and formats to suit every aesthetic and project specification.**

**Together, Roca's installation systems, flush plates and special frames combine form and function, supporting architects, designers and installers in creating efficient, stylish and long-lasting bathrooms. With attention to detail in both performance and design, this category is engineered to meet the demands of today and tomorrow.**

# Index

<b>Innovation Meets Precision</b>	<b>06</b>
<b>Flush Plates</b>	<b>12</b>
<b>PS Plates</b>	<b>14</b>
<b>PL Plates</b>	<b>54</b>
<b>Compatibility Plates vs Duplo Chart</b>	<b>84</b>
<b>Duplo Systems</b>	<b>86</b>
<b>Duplo WC S</b>	<b>88</b>
<b>Duplo WC One</b>	<b>98</b>
<b>Duplo Special Frames</b>	<b>108</b>
<b>Prefab Systems</b>	<b>122</b>
<b>Our Planet. Our Home</b>	<b>132</b>



06



12

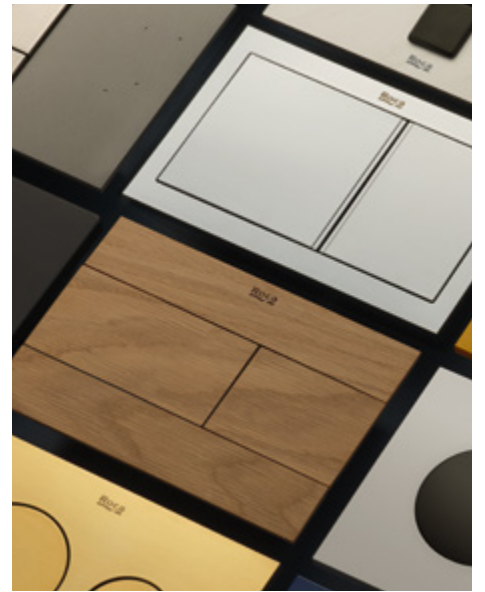

84



86



122



132

# Innovation Meets Precision

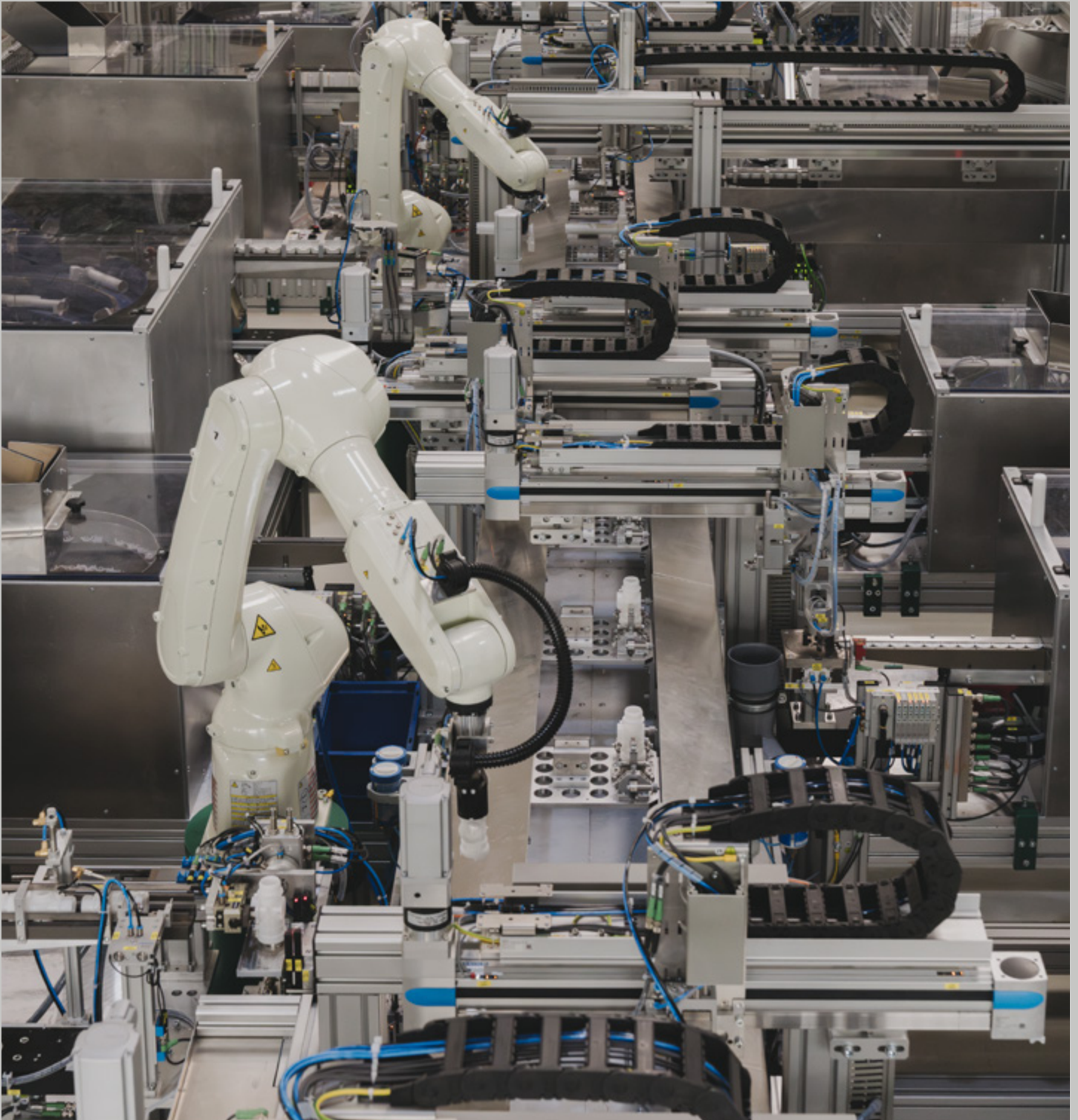

With over 80 years of experience, our Pre-Wall Installations Competence Center is a hub of engineering excellence. Based in Germany, it combines technical precision, innovation and manufacturing expertise to deliver high-performance solutions that respond to today's building challenges.

## Engineering Excellence Behind the Wall

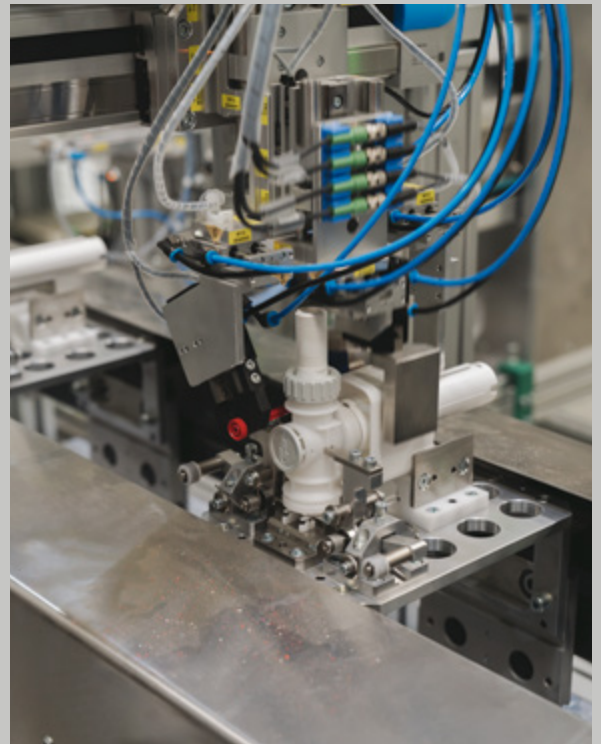

True innovation starts with strong foundations. The Pre-Wall Installations Competence Center plays a key role in driving engineering leadership within Roca Group. Its impact goes far beyond product development – it defines technical standards, transfers expertise, and nurtures a shared culture of precision and performance. Within its state-of-the-art testing and production facilities, ideas are engineered, validated and transformed into reliable, scalable solutions. With every process certified “Made in Germany,” the Competence Center sets the benchmark for installation systems across the Group – ensuring quality and consistency where it matters most: behind the wall.

## Built on Experience

Founded in 1945, our Installation System Competence Center has evolved from a local manufacturer into an internationally recognised leader in sanitary technology. With over eight decades of expertise, we have built on a tradition of excellence and have developed pioneering in-wall and installation systems.





## Innovation with Purpose

From the first plastic cistern developed, to the launch of the 4-litre cistern and dual-flush technology, our legacy of innovation reflects a clear goal: greater efficiency and smarter use of water. Every product is developed in-house, allowing us to optimise each component – from fill valves to in-wall systems – for functionality, sustainability and smart design.



## Reliability that Lasts

Our commitment goes beyond installation. With industry-recognised quality and a 25-year guarantee on the availability of spare parts for key components in our concealed cisterns, we offer long-term confidence and support – ensuring lasting value behind the wall.

## Performance by Design

As part of the Roca Group, SANIT contributes decades of engineering expertise and product development to our installation systems. Every detail – from flush plates to mounting structures – is precision-engineered and rigorously tested to meet international standards. Certified processes and the use of sustainable materials ensure long-lasting performance and responsible manufacturing.



# Flush Plates

Designed  
to be seen,  
engineered  
to perform



Flush plates are the visible interface of the installation systems – where design, function and user experience converge. More than just a finishing element, they reflect the precision behind the wall while adding a tactile and visual dimension to the bathroom space. Available in a curated selection of materials, textures and finishes, Roca's flush plates respond to evolving interior trends without compromising technical performance. From mechanical to touch-free electronic models, every detail is developed for intuitive use, hygiene and long-term reliability.



Roca's flush plates are designed to offer limitless design possibilities through a wide variety of finishes, enabling the creation of personalised and expressive bathroom spaces. Combining elegance with durability, they feature premium options, including PVD finishes in brushed brass, rose gold, titanium black and stainless steel. They also include bold colour options inspired by the Nu faucet range, or classic black and white for timeless appeal.

For those seeking material-led design, PS plates also come in distinctive finishes like glass, ceramics, wood, concrete, and slate. These tactile options bring warmth, texture, and character into the bathroom, offering a refined balance between natural inspiration and modern sophistication.

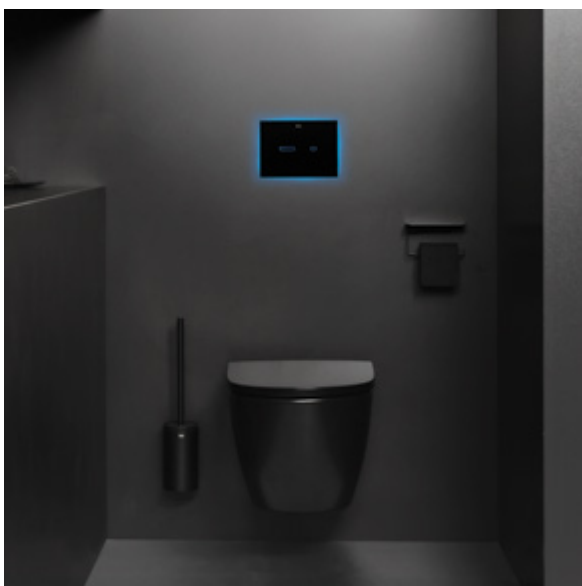

Beyond visual appeal, customisation plays a key role in creating a unique bathroom experience. With a variety of finishes, button styles and configurations, each flush plate can be tailored to suit individual preferences, offering a harmonious blend of personal expression and seamless integration.



# PS Plates

**PS flush plates offer efficient performance via cable technology and enable a bespoke bathroom look with a range of versatile styles, premium finishes and touchless options. This range, the perfect match for Duplo WC S, is unique in offering a customisation option: mix and match designs, materials and button colours to create a truly personalised flush plate.**

# PS Features

## Small Flush Plates

---

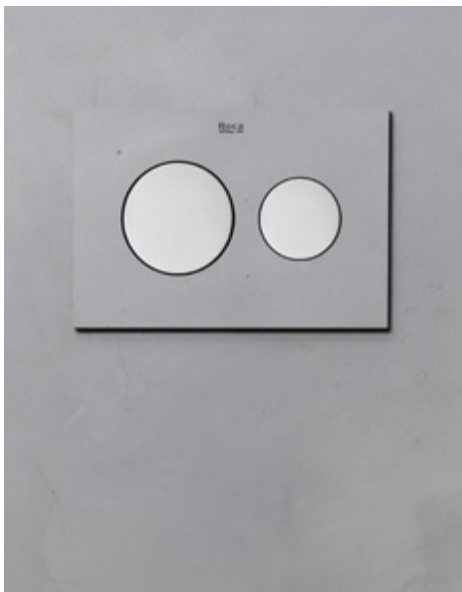

A new range of smaller flush plates available in a variety of textures, colours and materials.

## Modern Choices

---



An extensive selection of design options.

## Cable Technology

---



More and varied designs, easier installation and an actuating force below 25N.

## Electronic Version

---



Features include touchless automatic flushing, seven light colours, hygiene flush and Roca Connect connectivity.

## Expanded Finishes

---



A wide range of finishes, including luxurious PVD colours, vibrant hues from the Nu collection, and an array of attractive material finishes.

## Urinal Solution

---



Available for both mechanical and electronic plates, the urinal plates version comes in mains-powered and battery-powered options. There is also the possibility to upgrade from a mechanical to an electronic plate.

# Minimalist design, reliable flush control

With a discreet shape, the PS1 flush plate blends seamlessly into minimalist spaces. Its clean geometry reflects functional simplicity, bringing clarity to contemporary interiors. Perfect for understated designs where form meets subtle performance.

# PS1





00



01



06



07

#### PS1

Dual flush plate for Duplo S installation systems. Cable technology. No tools required for installation.

**A8902253..**

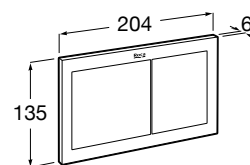

Dimensions in mm. Replace (...) in the product reference with the code of the chosen finish:

○ 00 White    ● 01 Chrome    ● 06 Matt Black    ● 07 Matt White

# Elegant style, intuitive flushing

PS2 combines a refined silhouette with a rich palette of finishes to enhance modern bathrooms. Some models incorporate real natural materials, including metal for PVD finishes, glass for glossy surfaces and oak for wood. Its soft touch and balanced proportions contribute to a seamless visual flow. As one of the smallest plates in the collection, it is ideal for minimalist spaces. It can also be installed level with the wall for a fully integrated, contemporary look.

## PS2









00



01



04



06



07



88



99



AA



00



NM



VA

## PS2 Dual

Dual flush plate for Duplo S installation systems. Cable technology. No tools required for installation.

**A8902243..**

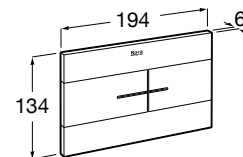

## Accessories

Flat Accessory for level with wall plate (for PS2 Dual, PS3 Dual and PS3 Dual Combi)

**A8906A0000**

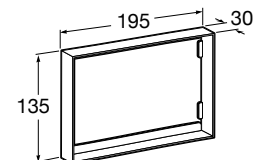

Dimensions in mm. Replace (...) in the product reference with the code of the chosen finish:

- 00 White
- 01 Chrome
- 04 Stainless Steel
- 06 Matt Black
- 07 Matt White
- AA Anthracite Glass
- 00 Oak
- NM Brushed Titanium Black
- VA Brushed Brass
- 88 Black Glass
- 99 White Glass

# Refined finishes, seamless functionality

This modern flush plate, the smallest in the range together with the PS2 model, can be installed level with the wall for a perfectly integrated look. It is available in a rich palette of colours and textures, ranging from standard colour and PVD to honey yellow and mint green. Designed for bathrooms with a strong design focus without compromising on functionality.

## PS3









00



01



04



06



07



NM



RG



CN



VA



PO



P1

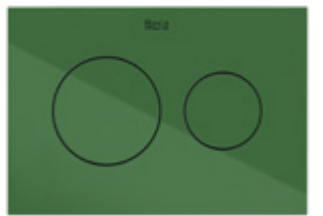

P2

### PS3 Dual

Dual flush plate for Duplo S installation systems. Cable technology. No tools required for installation.  
**A8902233..**

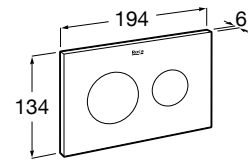

## Accessories

Flat Accessory for level with wall with wall plate (for PS2 Dual, PS3 Dual and PS3 Dual Combi)

**A8906A0000**

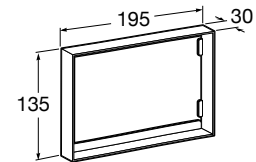

Dimensions in mm. Replace (...) in the product reference with the code of the chosen finish:

- 00 White
- 01 Chrome
- 04 Stainless Steel
- 06 Matt Black
- 07 Matt White
- CN Titanium Black
- RG Rose Gold
- NM Brushed Titanium Black
- VA Brushed Brass
- PO Cobalt Blue
- P1 Honey Yellow
- P2 Mint Green

# Personalized style, flexible options

Maximising the design and potential of the PS3 with a front panel featuring separate push buttons, the PS3 Combi allows users and designers to mix and match materials and finishes. Ideal for custom bathroom projects or premium designs.

## PS3 Combi

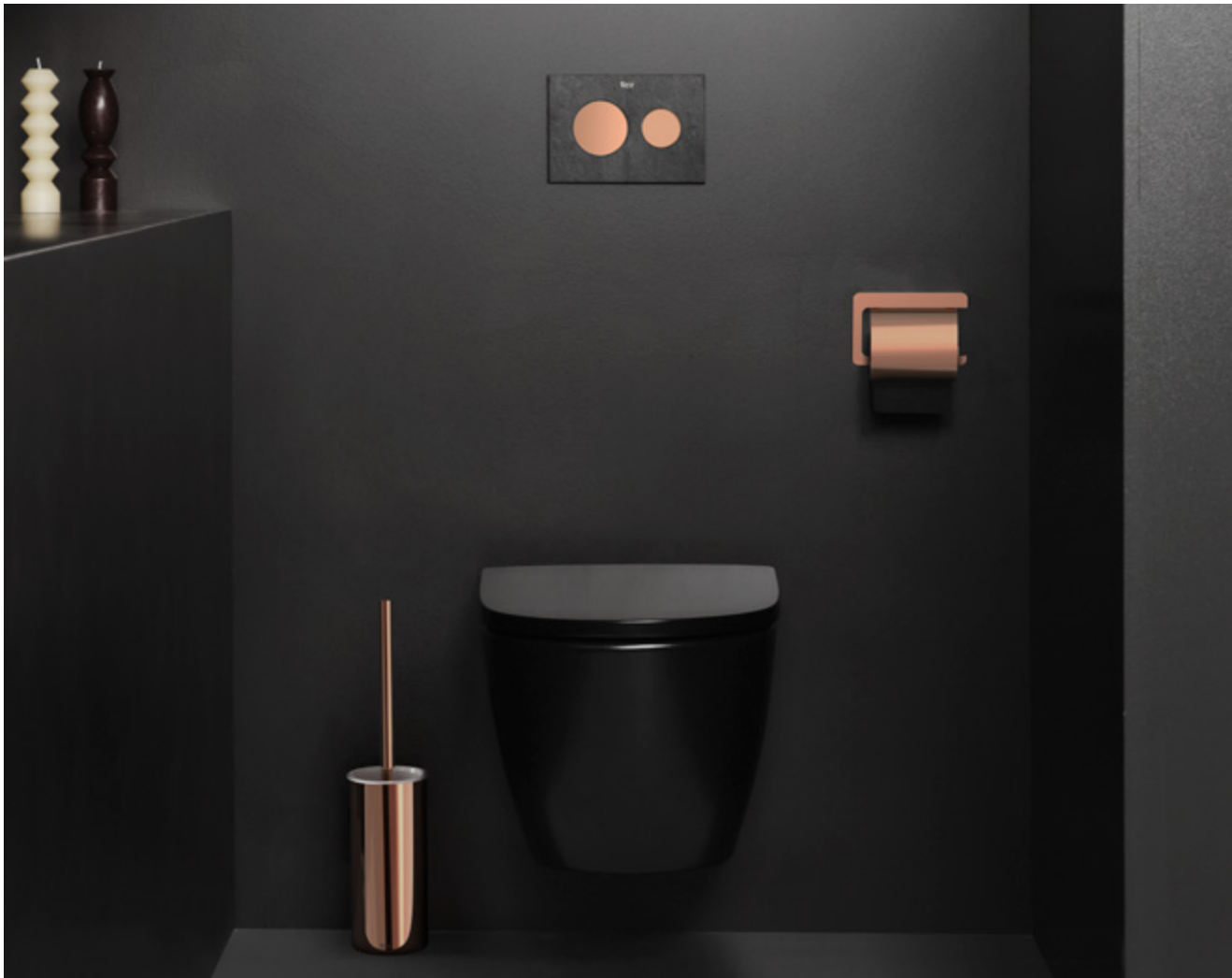



# PS3 Combi

## PS3 Front panel

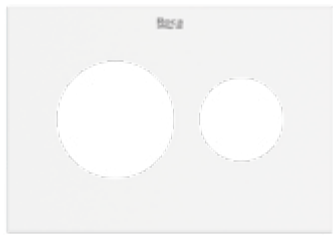

00

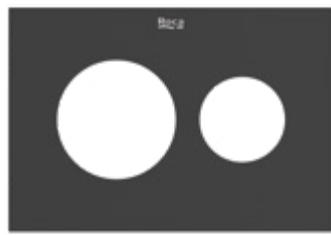

06

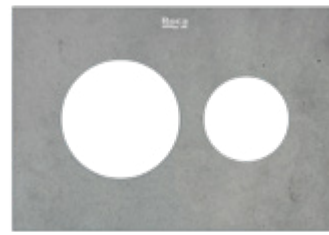

CC

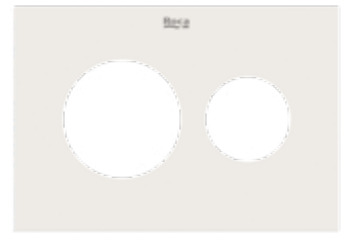

DD

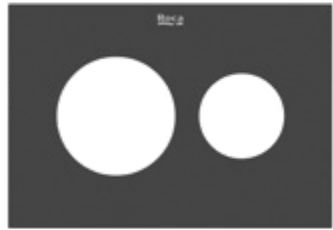

EE



MM

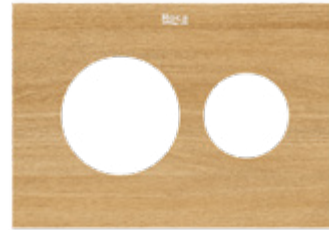

OO

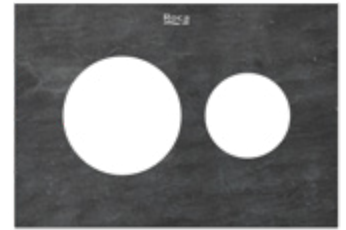

SS

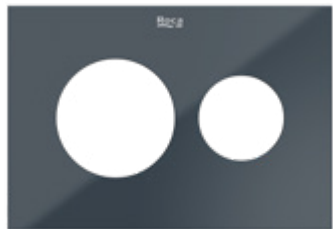

AA

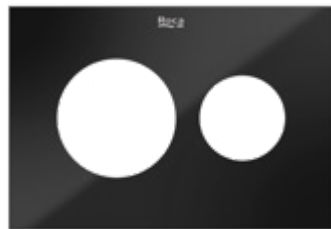

88

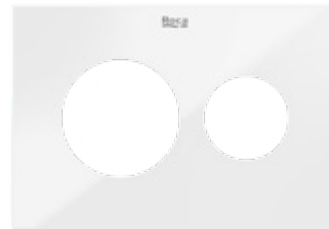

99

## PS3 push buttons



CN

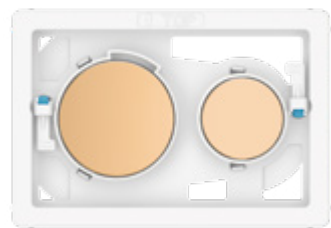

RG

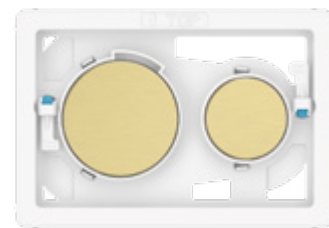

VA

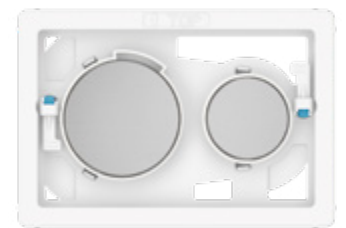

O4

# PS3 Combi

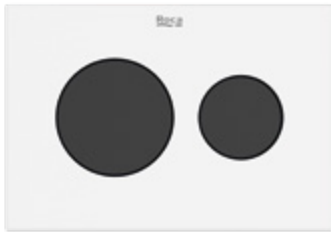

OO + CN

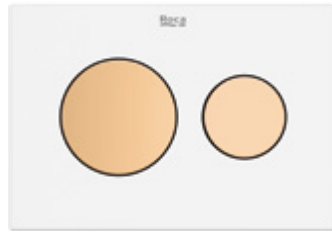

OO + RG

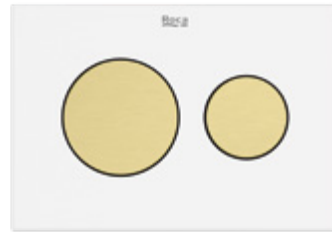

OO + VA

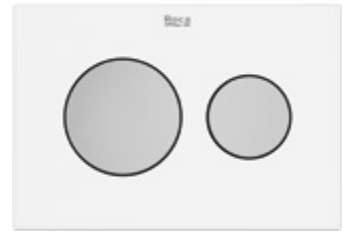

OO + O4



O6 + CN



O6 + RG



O6 + VA

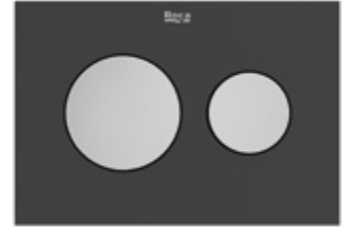

O6 + O4

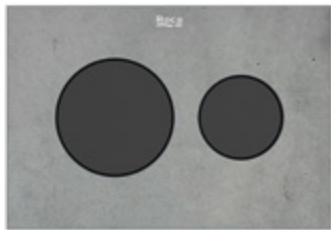

CC + CN

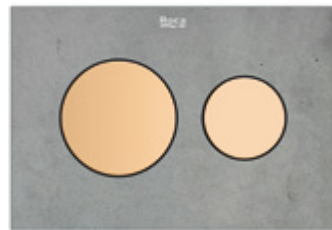

CC + RG

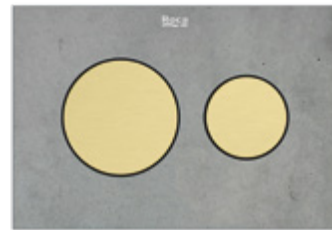

CC + VA

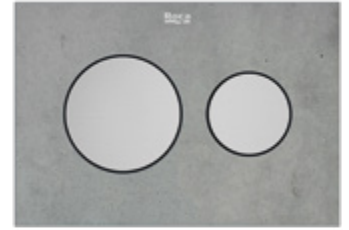

CC + O4

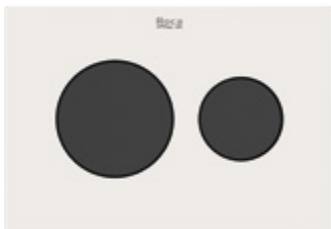

DD + CN

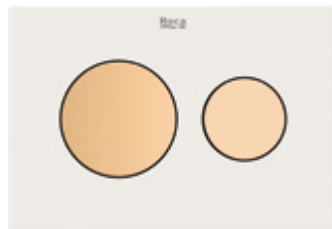

DD + RG

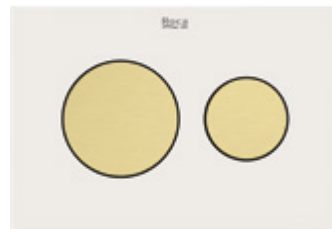

DD + VA

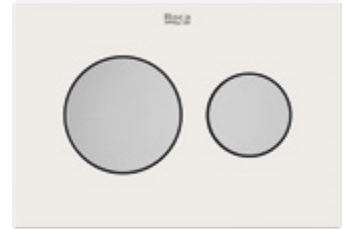

DD + O4

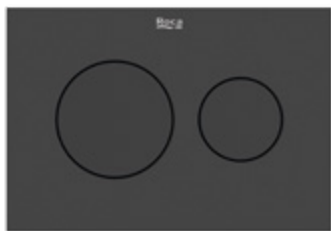

EE + CN



EE + RG

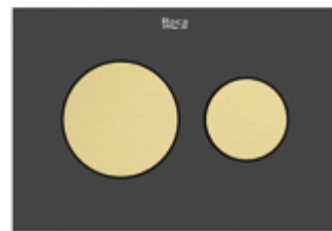

EE + VA

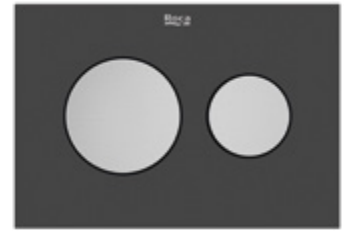

EE + O4



MM + CN



MM + RG



MM + VA



MM + O4



OO + CN

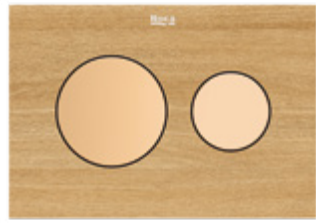

OO + RG

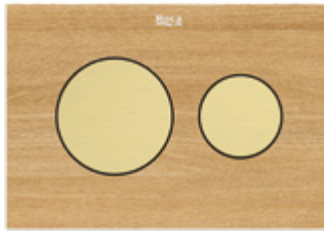

OO + VA

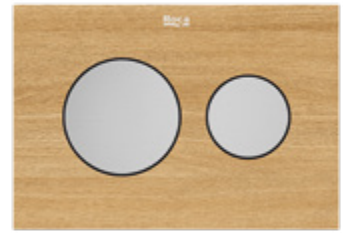

OO + O4

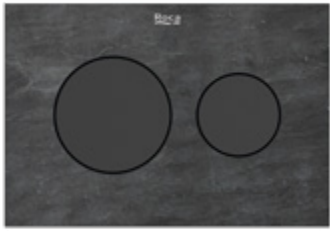

SS + CN



SS + RG

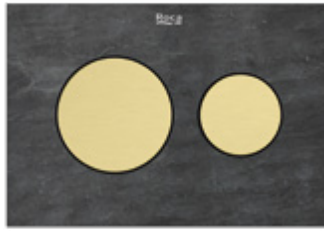

SS + VA

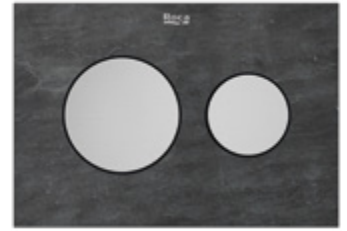

SS + O4



AA + CN



AA + RG



AA + VA



AA + O4



88 + CN



88 + RG



88 + VA



88 + O4



99 + CN

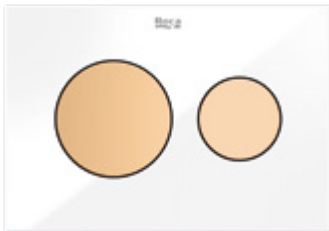

99 + RG

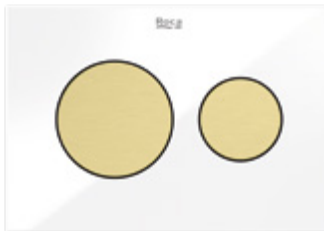

99 + VA

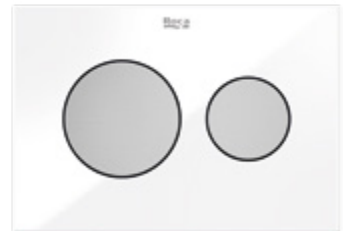

99 + O4

## PS3 Dual Combi

### PS3 Front panel

Front panel for PS3 push-button mechanism. Requires PS3 push buttons (ref. A89004233..) to complete the set.

**A8905233..**

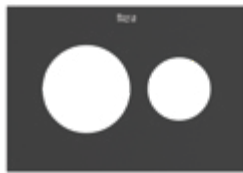

+



=

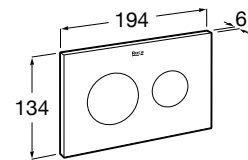
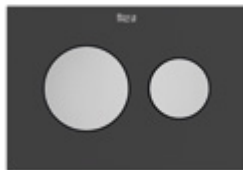

### PS3 Push Buttons

Push-button mechanism to be combined with PS3 front panel (ref. A8905233..). For Duplo S installation systems. Cable technology. No tools required for installation.

**A89004233..**

## Accessories

Flat Accessory for level with wall plate (for PS2 Dual, PS3 and PS3 Dual Combi)

**A8906A0000**

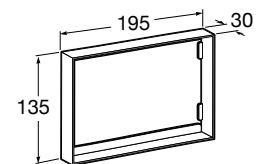

Dimensions in mm. Replace (...) in the product reference with the code of the chosen finish:

- |                     |                      |                    |                    |                       |            |
|---------------------|----------------------|--------------------|--------------------|-----------------------|------------|
| ○ 00 White          | ● 04 Stainless Steel | ● 06 Matt Black    | ● 88 Black Glass   | ● 99 White Glass      |            |
| ● CN Titanium Black | ● RG Rose Gold       | ● 00 Oak           | ● VA Brushed Brass | ● AA Anthracite Glass | ● SS Slate |
| ● CC Concrete       | ● DD White Ceramic   | ● EE Black Ceramic | ● MM Marble        |                       |            |

## Strong lines, architectural elegance

PS4 stands out for its structured form and architectural appeal. It brings a bold identity to design-led spaces without compromising on visual balance. Particularly well-suited for interiors that demand precision and style. Its premium character of the PS4 plate, makes it a statement piece in any bathroom.

# PS4









00



01



04



06

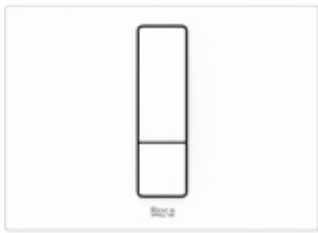

07



NM



VA



04

### PS4 Dual

Dual flush plate for Duplo S installation systems. Cable technology. No tools required for installation.

**A8902213..**

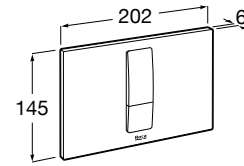

### PS4 Dual Pro

Vandal-proof stainless steel dual flush plate for Duplo S installation systems. Cable technology. No tools required for installation.

**A890221304**

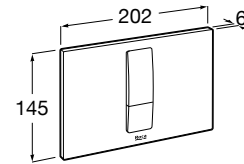

Vandal-proof

### PS4 Single Pro

Vandal-proof stainless steel single flush plate for Duplo S installation systems. Cable technology. No tools required for installation.

**A890221204**

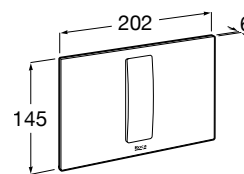

Vandal-proof

Dimensions in mm. Replace (...) in the product reference with the code of the chosen finish:

- 00 White
- 01 Chrome
- 04 Stainless Steel
- 06 Matt Black
- 07 Matt White
- NM Brushed Titanium Black
- VA Brushed Brass

## Modular design, premium functionality

PS4 Combi integrates aesthetics with powerful functionality for high-end bathroom projects., taking taking the design and possibilities of the PS4 to the fullest. The front panel and push button offer enhanced customisation. Made with real raw materials, including metal for PVD finishes, glass for sleek versions, or oak for wood finishes, it conveys an authentic, premium feel. These examples highlight the natural character and design versatility of the collection.

# PS4 Combi





# PS4 Combi

## PS4 Front panel



00



06

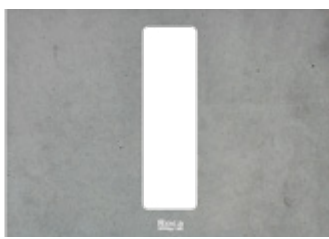

CC

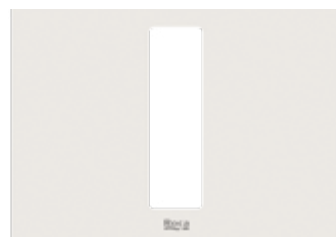

DD

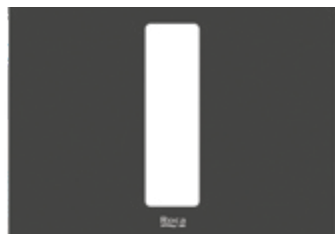

EE



MM



OO



SS



AA



88



99

## PS4 push buttons

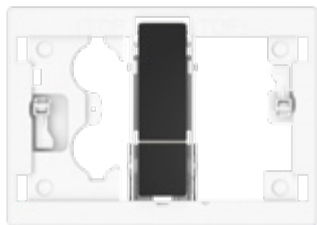

CN

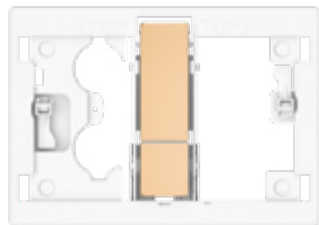

RG

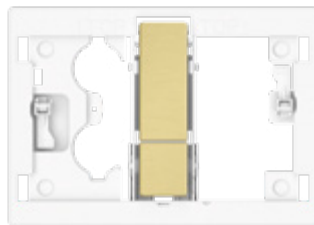

VA

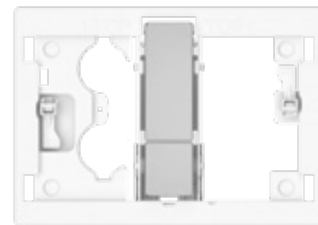

O4

# PS4 Combi



00 + CN

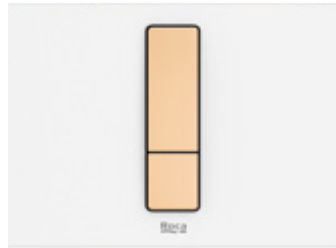

00 + RG

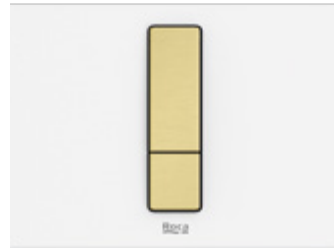

00 + VA



00 + O4



06 + CN

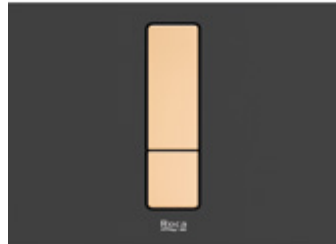

06 + RG



06 + VA



06 + O4



CC + CN

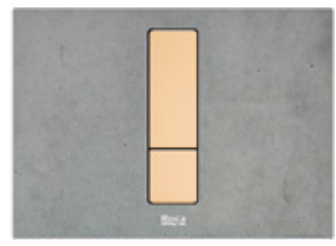

CC + RG

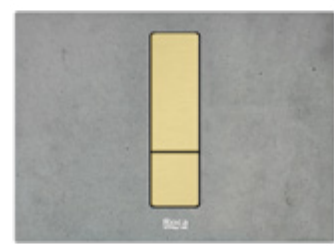

CC + VA

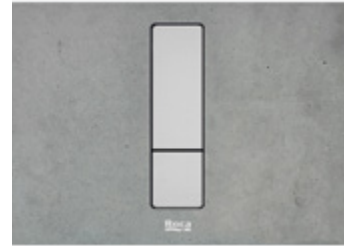

CC + O4



DD + CN

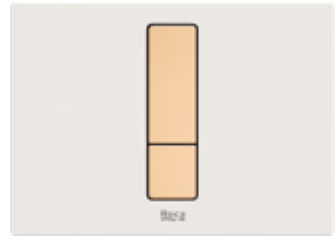

DD + RG

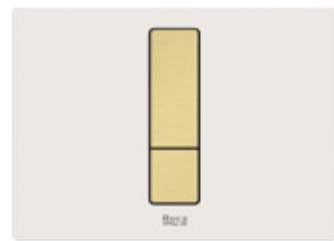

DD + VA

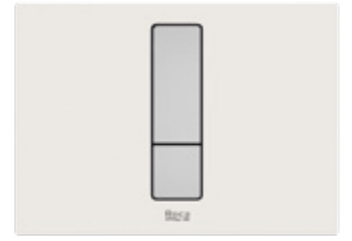

DD + O4



EE + CN

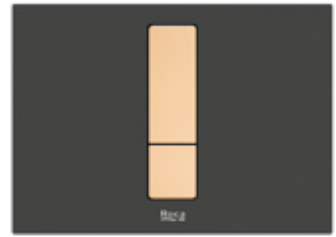

EE + RG



EE + VA

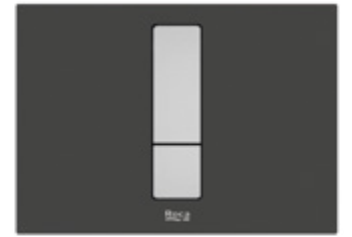

EE + O4



MM + CN

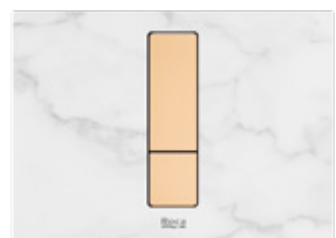

MM + RG



MM + VA



MM + O4

# PS4 Combi



OO + CN



OO + RG



OO + VA

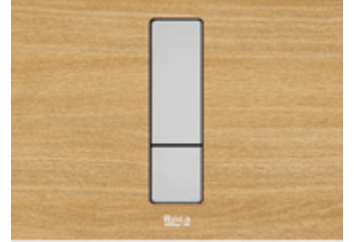

OO + O4



SS + CN

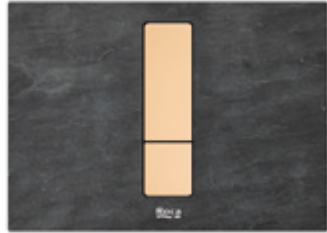

SS + RG



SS + VA



SS + O4



AA + CN



AA + RG



AA + VA



AA + O4



88 + CN



88 + RG



88 + VA



88 + O4



99 + CN

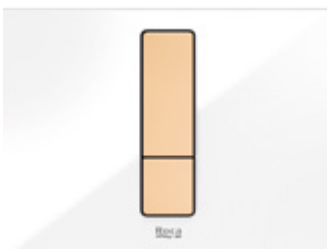

99 + RG

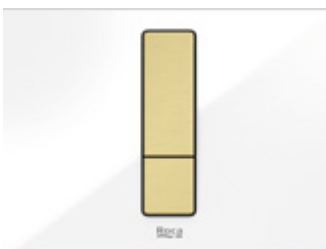

99 + VA



99 + O4

PS4 Dual Combi

PS4 Front Panel

Front panel for PS4 push-button mechanism. Requires PS4 push buttons (ref. A8904213..) to complete the set.

**A8905213..**

PS4 Push Buttons

Push-button mechanism to be combined with PS4 front panel (ref. A8905213..). For Duplo S installation systems. Cable technology. No tools required for installation.

**A8904213..**



+

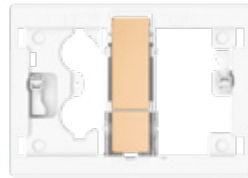

=

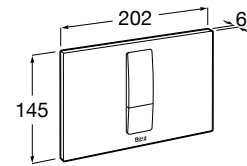

Dimensions in mm. Replace (...) in the product reference with the code of the chosen finish:

- |                     |                    |                      |                    |                       |                  |
|---------------------|--------------------|----------------------|--------------------|-----------------------|------------------|
| ○ 00 White          | ○ 01 Chrome        | ○ 04 Stainless Steel | ● 06 Matt Black    | ● 88 Black Glass      | ○ 99 White Glass |
| ● CN Titanium Black | ● RG Rose Gold     | ● 00 Oak             | ● VA Brushed Brass | ● AA Anthracite Glass | ● SS Slate       |
| ● CC Concrete       | ● DD White Ceramic | ● EE Black Ceramic   | ● MM Marble        |                       |                  |

# Bold geometry and efficiency

The PS5 flush plate features wide proportions and a sculptural presence. It combines expressive design with everyday functionality. Its distinctive push button geometry, unique within the collection, reinforces its bold identity while offering intuitive operation. A confident, modern statement that enhances refined bathroom environments.

## PS5





00

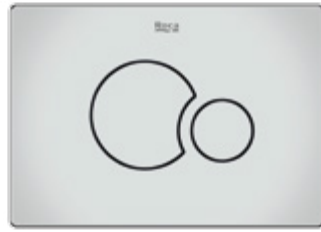

01

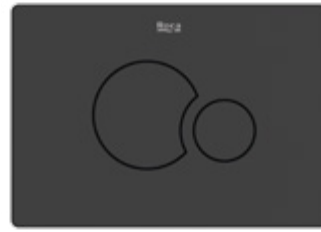

06

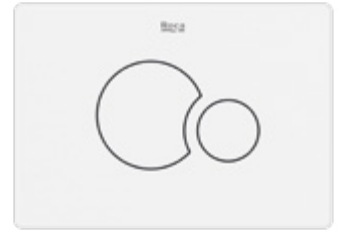

07

### PS5 Dual

Dual flush plate for Duplo S installation systems. Cable technology. No tools required for installation.

**A8902223..**

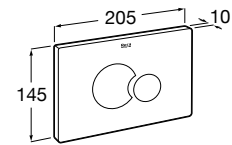

Dimensions in mm. Replace (...) in the product reference with the code of the chosen finish:

○ 00 White    ● 01 Chrome    ● 06 Matt Black    ● 07 Matt White

# Smart hygiene, modern flush control

EP-S1 is a smart, sensor-activated plate offering hygienic dual flush for modern spaces. Available in battery- and mains-powered versions for easy adaptability. Ideal for touchless experiences in private and semi-public spaces. When integrated with Roca Connect, it enables smart monitoring and data-driven management – improving maintenance efficiency and optimising water usage in high-traffic environments.

## EP-S1

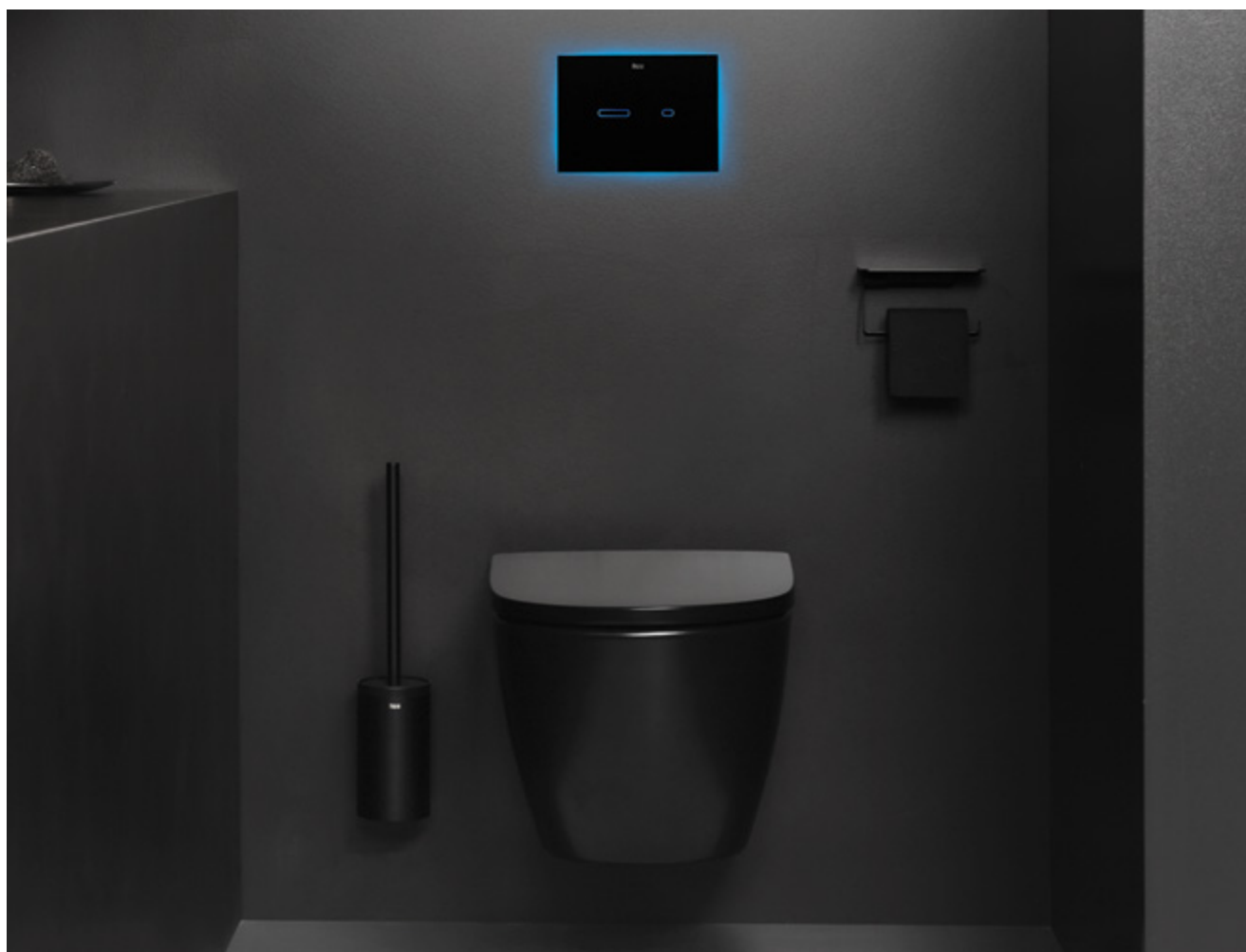



#### EP-S1 Electronic

Electronic flush plate for Duplo S installation systems. Mains operated. Roca Connect. Suitable for private and semi-public spaces.

**A890231088**

Electronic flush plate for Duplo S installation systems. Powered by batteries. Roca Connect. Suitable for private and semi-public spaces.

**A890231588**

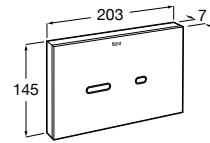

Touchless



Auto Flush

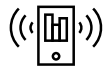

Roca Connect



Light

Dimensions in mm.

● 88 Black Glass

## Manual solution, refined appearance

PS Urinal is both durable and stylish and is suitable for commercial use. Available in a variety of finishes, ranging from standard colours to premium combinations featuring crystal and stainless steel buttons, it offers a versatile and refined aesthetic for any project.

# PS Urinal



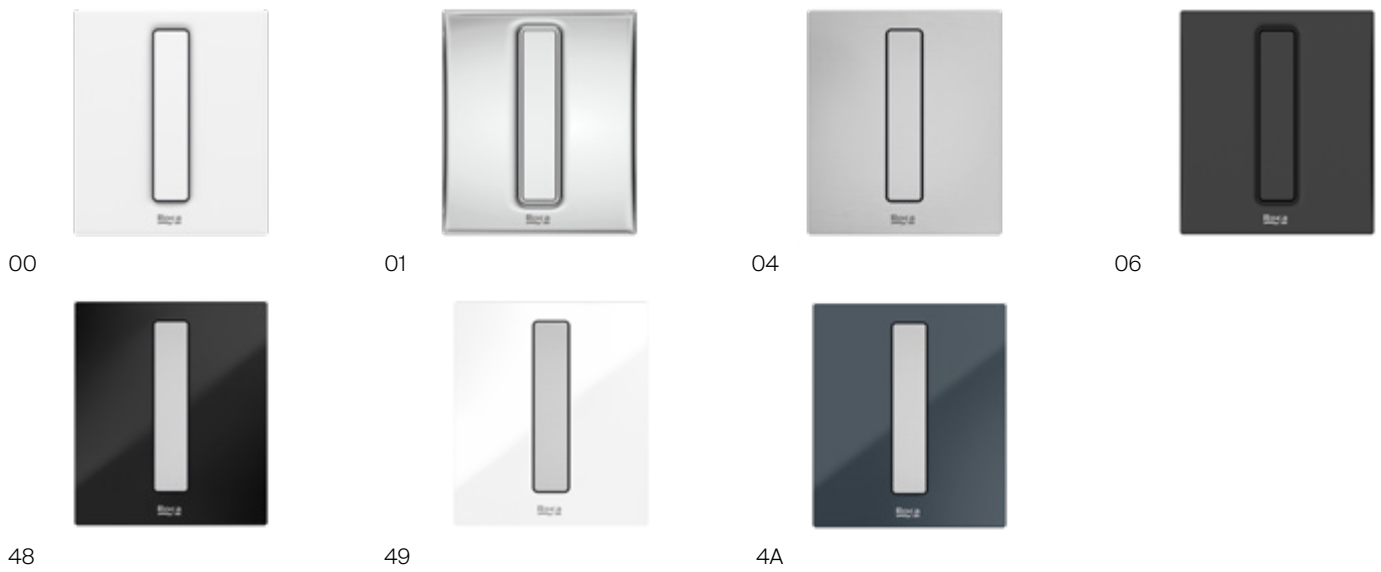

PS Urinal  
 Flush plate for Duplo S installation  
 systems. Mains operated.  
**A8903401..**

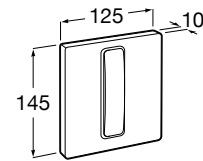

Dimensions in mm. Replace (...) in the product reference with the code of the chosen finish:

- 00 White
- 01 Chrome
- 04 Stainless Steel
- 06 Matt Black
- 48 Black Glass
- 49 White Glass
- 4A Anthracite Glass

# Hands-free flushing for urinals

A compact electronic plate with automatic sensor activation for urinals. Ideal for public or semi-public restrooms where hygiene and water efficiency are essential. With the battery-powered versions, upgrading a PS urinal to an EPS model is always possible—no renovation required by batteries alternative.

## EPS Urinal





00



01



04

---

#### EPS Urinal

Electronic flush plate for Duplo S installation systems. Powered by batteries.

**A8903505..**

Electronic flush plate for Duplo S installation systems. Mains operated.

**A8903504..**

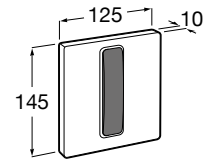

Auto Flush

---

Dimensions in mm. Replace (...) in the product reference with the code of the chosen finish:

○ 00 White

● 01 Chrome

● 04 Stainless Steel







# PL Plates

**PL flush plates combine a streamlined design with practical functionality, providing the ideal complement to Duplo One installation systems. With a modern aesthetic and a wide range of finishes, PL plates can be used in a variety of bathroom styles.**

# PL Features

## Variety of Designs

---



A wide range of well-designed flush plates is available to offer a style to suit every taste. These models have been present in the market for years, standing out for their reliability, performance, and consistent demand among installers and consumers.

## Multiple Finishes

---



Elegant finishes – including standard, matt, glass and PVD – designed to enhance any bathroom setting with a touch of sophistication and versatility, adapting seamlessly to both classic and contemporary styles.

## Electronic Plates

---



A comprehensive selection of electronic plates for all environments, whether public, semi-public or private, is available. From basic functionality to advanced features including touchless operation, automatic flushing, and Roca Connect connectivity.

## Easy Plate Assembly

---



PL plates can be installed and dismantled easily and intuitively without the need for tools.

## Soft Touch and Short Run

---



The plates have been designed to activate the flush when a force of under 25N is applied, which is well below the norm requirement, and with a run of under 10 mm.

# Essential form, effortless function

Defined by geometric simplicity, the PL1 stands out for its clean lines and traditional finishes that suit minimalist, timeless interiors. As the first model in the range and a long-standing bestseller, the PL1 has proven its reliability and enduring appeal. A practical and discreet solution for efficient bathroom design.

## PL1





00



00



01



02

#### PL1 Single

Single flush plate for Duplo One installation systems. No tools required for installation.

**A890195100**

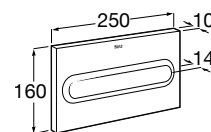

#### PL1 Dual

Dual flush plate for Duplo One installation systems. No tools required for installation.

**A8901950..**

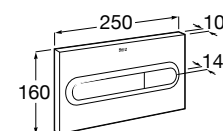

Dimensions in mm. Replace (...) in the product reference with the code of the chosen finish:

○ 00 White    ● 01 Chrome    ● 02 Chrome Matt

## Soft lines, refined balance

PL2 features curved contours and a more tactile, inviting feel. Available in white, chrome and matt chrome, it exudes subtle elegance. A perfect match for sophisticated environments where design is felt, not forced.

# PL2





00



00



01



02

#### PL2 Single

Single flush plate for Duplo One installation systems. No tools required for installation.

**A890196100**

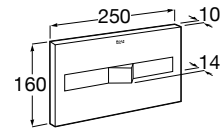

#### PL2 Dual

Dual flush plate for Duplo One installation systems. No tools required for installation.

**A8901960..**

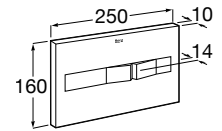

Dimensions in mm. Replace (...) in the product reference with the code of the chosen finish:

○ 00 White    ● 01 Chrome    ● 02 Chrome Matt

# Strength meets clean design

Designed for resilience and discretion, the PL3 Pro is a stainless Steel, vandal-resistant flush plate. Ideal for public or high-traffic environments, it offers long-lasting performance and a timeless industrial appeal.

## PL3 Pro





04



04

---

#### PL3 Pro Single

Vandal-proof stainless steel single flush plate for Duplo One installation systems. No tools required for installation..

**A890197104**

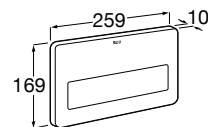

Vandal-proof

---

#### PL3 Pro Dual

Vandal-proof stainless steel dual flush plate for Duplo One installation systems. No tools required for installation.

**A890197004**

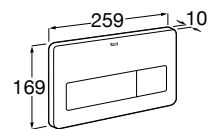

Vandal-proof

---

Dimensions in mm.

● 04 Stainless Steel

# A space elevated by design

The PL7 redefines elegance with its bold finishes, including matt black, matt white, black glass and white glass. This is a flush plate is designed to stand out in premium interiors.

## PL7





06



07



08



09

PL7 Dual

Dual flush plate for Duplo One installation systems. No tools required for installation.

**A890188206**

**A890188207**

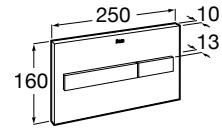

PL7 Dual

Dual flush plate for Duplo One installation systems. No tools required for installation.

**A890188308**

**A890188309**

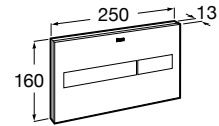

Dimensions in mm.

● 06 Matt Black

● 07 Matt White

● 08 Black Glass

● 09 White Glass

## Tailored finishes, enhanced control

The most versatile model in the range, the PL10 comes in a variety of finishes, from basic to premium, including all PVD, glass and special colours. It allows designers to fully align technical details with the personality of a space.

# PL10







000



001



002



OCN

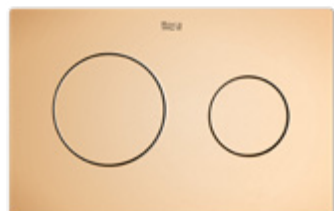

ORG



ONM



OVA



308



309



206



207



20M



20B



20P



264

---

PL10 Dual

Dual flush plate for Duplo One installation systems. No tools required for installation.

**A890189...**

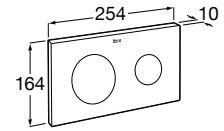

---

PL10 Dual

Dual flush plate for Duplo One installation systems. Glass finishes. No tools required for installation.

**A8901892308**

**A8901892309**

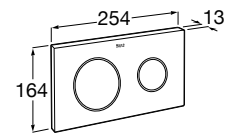

---

Dimensions in mm. Replace (...) in the product reference with the code of the chosen finish:

- |                      |                 |                              |                     |                  |                   |                   |
|----------------------|-----------------|------------------------------|---------------------|------------------|-------------------|-------------------|
| ○ 000 White          | ● 001 Chrome    | ● 002 Chrome Matt            | ● 206 Matt Black    | ● 207 Matt White | ● 308 Black Glass | ● 309 White Glass |
| ● 0CN Titanium Black | ● 0RG Rose Gold | ● 0NM Brushed Titanium Black | ● 0VA Brushed Brass |                  |                   |                   |
| ● 20P Pearl          | ● 20B Beige     | ● 264 Onyx                   | ● 20M Coffee        |                  |                   |                   |

## Durability meets design

The PL10 Pro offers robust, vandal-resistant performance in a sleek stainless steel design. Its minimalist design is ideal for high-traffic or public spaces. Engineered for strength without sacrificing visual appeal. Distinguishing itself as the most vandal-resistant plate on the market, it features an direct wall-fixing system that provides extra security and prevents tampering.

# PL10 Pro





04

---

**PL10 Pro Dual**

Vandal-proof stainless steel dual flush plate for Duplo one installation systems. No tools required for installation.

**A890189304**

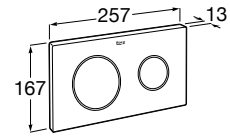

---

Vandal-proof

---

Dimensions in mm.

● 04 Stainless Steel

## Smooth and easy control

This plate is the ideal choice for accessible bathrooms. It can be installed in a different location to the standard flush plate, making it easier for users to operate. Its large button design is also a distinctive feature that makes it ideal for users with specific accessibility requirements.

# PL Pneumatic





00

---

Dual flush plate with pneumatic activation for Duplo One installation systems. No tools required for installation.

**A890166000**

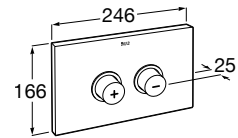

---

Dimensions in mm.

○ 00 White

# Touchless technology, industrial strength

The PL3-E Pro combines automatic flush technology with a vandal-proof, stainless steel construction. With manual override and automatic activation, it is ideal for busy public spaces where hygiene and reliability are paramount.

## PL3-E Pro



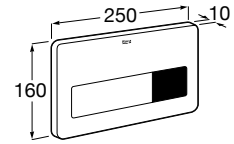

04

---

#### PL3-E PRO Dual Electronic

Electronic stainless steel dual flush plate for Duplo one installation systems with automatic or manual activation. No tools required for installation..

**A890097500**

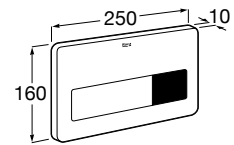

Vandal-proof



Auto Flush

---

Dimensions in mm.

● 04 Stainless Steel

## Advanced technology, elegant control

The PL10-E offers manual or automatic activation via a presence sensor and is compatible with Roca Connect, a smart bathroom solution that enables remote control, data analysis, and predictive maintenance of bathroom installations. Combining innovation with visual purity, the PL10-E is ideal for private and semi-public spaces. The PRO version provides the highest level of vandal-proof resistance for more demanding environments.

# PL10-E & PL10-E Pro





01



04

**PL10-E Dual Electronic**

Electronic dual flush chrome plate for Duplo one installation systems with automatic or touchless activation. Automatic autoflush with presence sensor. Suitable for private and semi-public spaces. No tools required for installation.

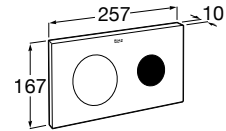

**A890189510**

**A890189520** *Roca Connect*



Auto Flush



Roca  
Connect

**PL10-E Pro Dual Electronic**

Electronic vandal-proof stainless steel dual flush plate for Duplo one installation systems with automatic or touchless activation. Automatic autoflush with presence sensor. Suitable for private and semi-public spaces. Includes additional direct fixing. No tools required for installation.

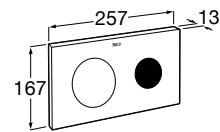

**A890189500**

**A890189530** *Roca Connect*



Vandal-proof



Auto Flush



Roca  
Connect

Dimensions in mm.

● 01 Chrome

● 04 Stainless Steel

# Glass finish, touchless precision

The EP-1 features a sleek glass surface with sensor activation and adjustable lighting. Its contactless operation and smart functionality ensure maximum hygiene. An ideal option for bathrooms that prioritise cleanliness and style.

# EP-1





08

#### EP-1 Dual Electronic

Electronic glass-finished dual-flush plate for Duplo One installation systems with automatic or touchless activation and adjustable colour lighting. Autoflush with sensor presence. Suitable for private and semi-public spaces. No tools required for installation.

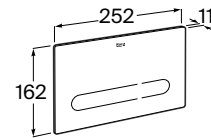

**A890104008**



Touchless



Auto Flush



Light

Dimensions in mm.

● 08 Black Glass

# Smart aesthetics, seamless interaction

With its refined glass surface and touchless technology, the EP-2 offers an effortless and hygienic flushing experience. Its presence sensor enables automatic or contactless activation, making it ideal for private and semi-public spaces. Customisable LED lighting completes this elegant solution.

## EP-2





---

#### EP-2 Dual Electronic

Electronic glass-finished dual-flush plate for Duplo One installation systems with automatic or touchless activation and adjustable colour lighting. Autoflush with sensor presence. Suitable for private and semi-public spaces. No tools required for installation.

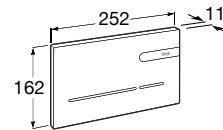

**A890104009**



Touchless



Auto Flush



Light

---

Dimensions in mm.

● 09 White Glass

# Minimal design, intuitive performance

The EP-3 features a touchless activation for enhanced hygiene and comfort. Designed for both private and semi-public spaces, it offers reliable dual-flush control with no physical contact. Its minimalist aesthetic integrates seamlessly into contemporary bathrooms.

## EP-3





19

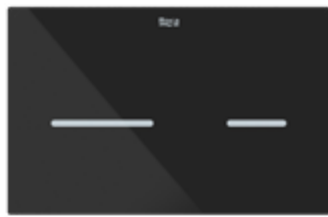

18



63



64



65

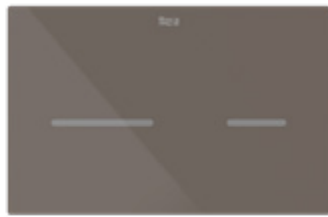

66

### EP-3 Dual Electronic

Electronic dual flush plate for Duplo One installation systems with touchless (hand detection) activation. Suitable for private and semi-public spaces. No tools required for installation. Glass finish.

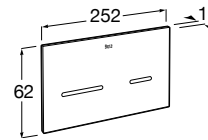

**A8901043..**

















Touchless

Dimensions in mm. Replace (...) in the product reference with the code of the chosen finish:

- 19 White
- 18 Black
- 63 Pearl
- 65 Beige
- 64 Onyx
- 66 Coffee

# Compatibility Plates vs Duplo Chart

	PS1	PS2	PS3	PS3 Combi	PS4	PS4 Combi	PS4	PS5 PRO	EPS1	EPS Urinal	PS Urinal
Duplo WC S Compact 	•	•	•	•	•	•	•	•	•		
Duplo WC S Smart Compact 	•	•	•	•	•	•	•	•	•		
Duplo WC S Standard 	•	•	•	•	•	•	•	•	•		
Duplo WC S Accessible 	•	•	•	•	•	•	•	•	•		
Duplo WC S Underwindow 	•	•	•	•	•	•	•	•	•		
Basic Tank S Underwindow 	•	•	•	•	•	•	•	•	•		
Duplo S Urinal Fluxor 										•	•
Duplo WC One 											
Duplo WC One Compact 											
Duplo WC One Freestanding 											
Duplo WC One Smart 											
Duplo WC One Underwindow 											
Basic WC One Compact 											
Basic Tank One Compact 											
Basic Tank One Underwindow 											



# Duplo Systems

Innovation  
behind the  
world



**Duplo combines advanced engineering with everyday convenience. Compatible with all Roca toilets – including smart models – Duplo S and Duplo One offer water-saving dual flush options, tool-free plate installation, silent operation and compact design. With multiple frame types and customisable features, these systems ensure adaptability, comfort, and top performance across all wall types.**

Designed to suit a wide range of bathroom configurations, the Duplo S installation system offers unparalleled versatility and innovation. Whether renovating or building from scratch, these systems ensure seamless installation and easy maintenance, providing the flexibility to create a bathroom that is both visually stunning and highly efficient. They are also designed to work seamlessly with PS flush plates, ensuring cohesive integration and design continuity.

The Duplo One installation systems are engineered for strength, simplicity and long-lasting performance. Providing a durable and discreet solution for wall-hung and back-to-wall toilets, they are easy to install, offer outstanding load resistance, and are fully compatible with Roca's wide range of flush plates. The compact cistern design allows for maximum space optimisation in bathrooms of any size.





Roca

# Duplo WC S

**Duplo WC S is a top-of-the-range installation system with small, slim plates. Available in a variety of new finishes and colours, it is fully compatible with all Roca toilets. This silent, water-saving solution uses cable technology to ensure a soft touch and quick and easy plate assembly without the need for additional tools.**

# Duplo WC S Features

## Versatile Solution

---



A highly adaptable installation that guarantees seamless compatibility with all Roca toilets. The Duplo WC S can accommodate various installation configurations, including standard, compact, under window and smart models.

## Quick and Easy Installation

---



Designed for convenience and maximum efficiency, the Duplo WC S offers a range of features that simplify the installation process:

- Cable technology for fast plate assembly without tools
- An easy height adjustment mechanism with a brake system for precise adaptability
- Easy adjustment of the position and angle of the outlet pipe
- Easy adjustment of the feet using a rotation system
- Quick wall fixations, design with micro-steps for perfect and easy adjustment

## Efficient Water Management

---



Advanced water-saving technology provides precise control over flushing volumes, offering 6/3 l, 4.5/3 l and 4/2 l options to suit individual needs. It also includes a flow manager system to maximise control of water speed.

## Maximum Comfort

---



Designed with user comfort in mind, the Duplo S features innovative cable technology for quiet and soft-touch operation. With a noise level of less than 20 dB(A), it meets EU standards for acoustic levels and is classified as Class I in EN 14124.

## Adaptable and efficient installation system

With its improved frame and flexible connection options, it suits a wide range of installation needs and offers a practical solution for contemporary bathrooms. Designed for quick and easy installation, the Duplo WC S ensures efficient water management while providing users with maximum comfort. A smart choice that combines functionality with modern bathroom design.

# Duplo WC S





### Duplo WC S Compact

Built-in structure with compact dual-flush cistern for wall-hung WC, minimum depth of 90 mm. Axial distance of 180 and 230 mm. Elbow Ø90/Ø110. Metallic profile capable of withstanding 400 kg. Adjustable feet from 0-200 mm with braking system. Top water inlet (accessible for top and lateral pipe connection). Flushing mechanism with Dual Cable Technology. To be completed with a compatible Roca PS operating plate (not included).

**A8900A0020**

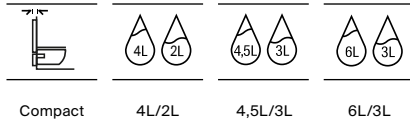
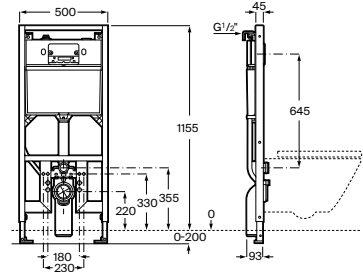

### Duplo WC S Smart Compact

Duplo WC S Smart Compact. Built-in structure with compact dual-flush cistern for Smart Toilets and installation accessories, inlet flexible hose and corrugated tube, installation minimum depth 90 of mm. Elbow Ø90/Ø110. Metallic profile capable of withstanding 400 kg. Adjustable height feet from 0-200 mm with braking system. Top water inlet (accessible for top and lateral pipe connection). Flushing mechanism with Dual Cable Technology. To be completed with a compatible Roca PS operating plate (not included)

**A8900A8020**

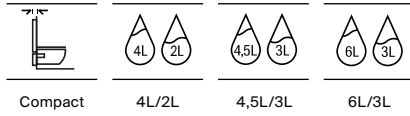
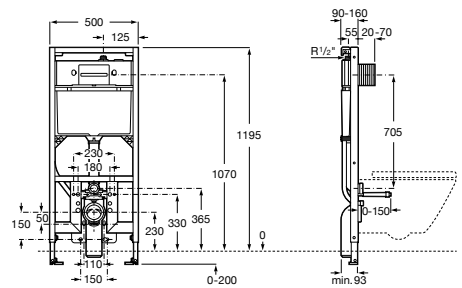

### Duplo WC S Standard

Built-in structure with dual-flush cistern for wall-hung WC, installation minimum depth of 135 mm. Elbow Ø90/Ø110. Metallic profile capable of withstanding 400 kg. Adjustable height feet from 0-200 mm with braking system. Top water inlet (accessible for top and lateral pipe connection). Flushing mechanism with Dual Cable Technology. To be completed with a compatible Roca PS operating plate (not included).

**A8900A912E**

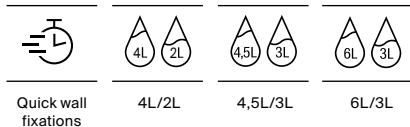
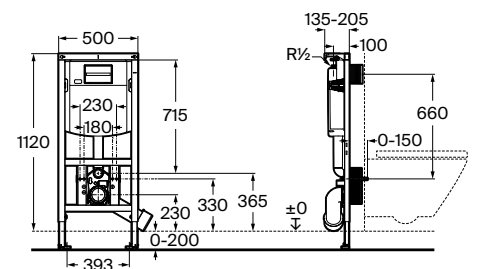

### Duplo WC S Accessible

Built-in structure with compact dual-flush cistern for wall-hung WC, installation minimum depth of 135 mm. Wall hung WC installation 50mm higher. Axial distance of 180 and 230 mm. Elbow Ø90/Ø110. Metallic profile capable of withstanding 400 kg. Adjustable height feet from 0-200 mm with braking system. Top water inlet (accessible for top and lateral pipe connection). Flushing mechanism with Dual Cable Technology. To be completed with a compatible Roca PS operating plate (not included).

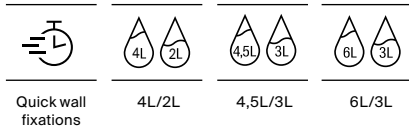
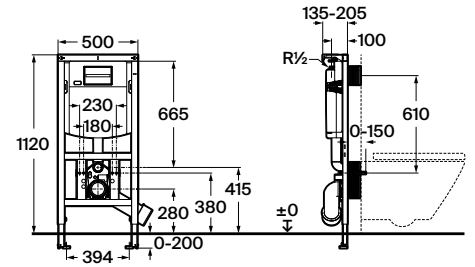

### Duplo WC S Underwindow

Low height built-in structure for toilet with dual-flush cistern for wall-hung WC, installation minimum depth of 155 mm. Elbow Ø90/Ø110. Metallic profile capable of withstanding 400 kg. Adjustable feet from 0-200 mm with braking system. Lateral water inlet. Allows front or top activation. Flushing mechanism with Dual Cable Technology. To be completed with a compatible Roca PS operating plate (not included).

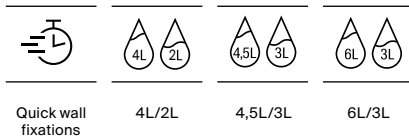
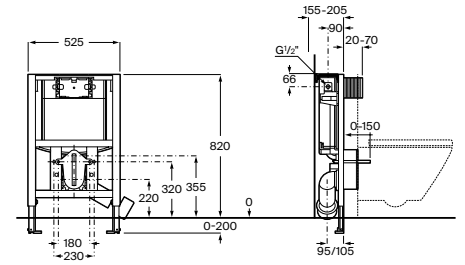

### Basic Tank Underwindow

Low height concealed cistern for single floorstanding toilets with dual-flush cistern, installation minimum depth of 155 mm. Lateral water inlet. Allows front or top activation. Flushing mechanism with Dual Cable Technology. To be completed with a compatible Roca PS operating plate (not included).

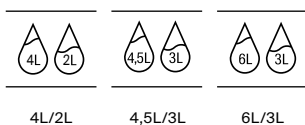
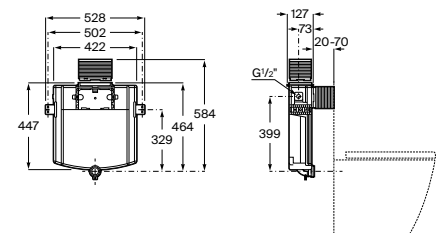







Roca

# Duplo WC One

**The Duplo WC One is a versatile and innovative installation system that can be adapted to suit a wide range of sites and toilet types. Offering ease of installation and smart functionality, it features height-adjustable frames, tool-free mounting of the flush plate and configurable dual-flush settings. The Duplo WC One meets the highest acoustic standards and offers enhanced noise reduction. It is compatible with PL flush plates and delivers performance, reliability and convenience in a single solution.**

# Duplo WC One Features

## Space-Saving

---



With a space-saving design incorporating all internal components and the cistern and measuring just 80 mm in depth and 460 mm in width, the Duplo WC One provides reduced installation space and more room in the bathroom.

## Wider Range

---



The Duplo WC One is suitable for any site requirement. It features a comprehensive range of toilet installation systems, including smart, compact, under window and freestanding versions, as well as solutions for both wall-hung and back-to-wall toilets.

It is compatible with both wet and dry installations.

## Water-Saving

---



The Duplo WC One features a water inlet valve that opens in a controlled manner to ensure the cistern only refills once flushing is complete. It also has a double float system that guarantees an efficient and correct filling process.

It comes with low-consumption settings (4/2 l, 4.5/3 l, 6/3 l) and flow restrictors for enhanced flushing control.

## Maximum Adjustability and Comfort

---



An insulated cistern reduces condensation and minimises noise levels when being refilled. The inlet valve components and polystyrene insulation have been optimised for noise reduction. Duplo One cisterns can achieve a noise level of less than 20dB in rooms close to the bathroom, earning a Class I classification – the best possible within the EN 14124 standard.

The outlet position can be adjusted precisely with an easy height adjustment mechanism with a brake system.

The Duplo One can withstand up to 400 kg, ensuring exceptional durability and reliability for your installation system.

It includes an easy height adjustment mechanism with brake system for precise adaptability and easy adjustment of the outlet position.

## Maximum support, minimum depth

The Duplo WC One is an ideal space-saving solution for bathrooms where every centimetre counts, combining structural strength with a compact cistern. With a wide range of models, it adapts to different wall types and installation scenarios. Designed with safety and user comfort in mind, it is height adjustable and helps save water, making it a smart choice for residential and commercial projects alike.

# Duplo WC One







### Duplo WC One

Built-in structure with compact dual flush cistern for wall-hung WC, minimum depth of 107 mm. Axial distance of 180 and 230 mm.  $\varnothing 90$  /  $\varnothing 110$  elbow. Metallic profile capable of withstanding 400 kg. Adjustable feet from 0-200 mm with braking system. Upper hydraulic connections. To be completed with a compatible Roca flush plate (not included).

**A890070020**

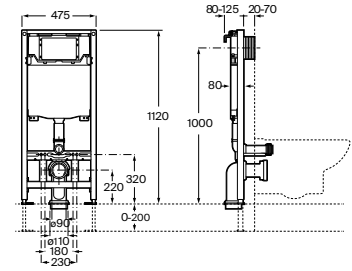
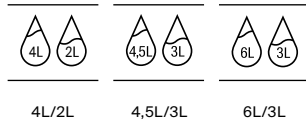

### Duplo WC One Compact

Built-in structure with compact dual flush cistern for wall-hung WC, minimum depth of 90 mm. Axial distance of 180 and 230 mm.  $\varnothing 90$  /  $\varnothing 110$  elbow. Metallic profile capable of withstanding 400 kg. Adjustable feet from 0-200 mm with braking system. Upper hydraulic connections. To be completed with a compatible Roca flush plate (not included).

**A890073020**

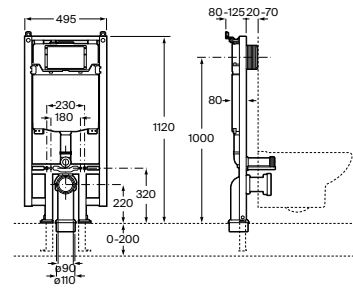
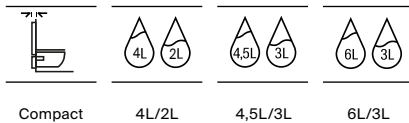

### Duplo WC One Freestanding

Built-in structure with compact dual flush cistern for wall-hung WC, minimum depth of 200 mm. Axial distance of 180 and 230 mm. No supporting wall is required.  $\varnothing 90$  /  $\varnothing 110$  elbow. Metallic profile capable of withstanding 400 kg. Adjustable feet from 0-200 mm with braking system. Upper hydraulic connections. To be completed with a compatible Roca flush plate (not included).

**A890077020**

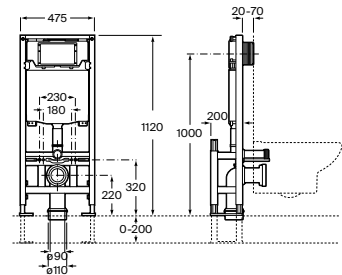

### Duplo WC One Smart

Built-in structure with compact dual flush cistern, flexible inlet pipe for smart toilets, corrugated pipe and installation accessories, minimum depth of 107 mm, height 1,190 mm and  $\varnothing 90 / \varnothing 110$  elbow. Axial distance of 180 and 230 mm. Recommended for the installation of In-Wash® Inspira / Ona wall-hung WC. Metallic profile capable of withstanding 400 kg. Adjustable feet from 0-200 mm with braking system. Upper hydraulic connections. To be completed with a compatible Roca flush plate (not included).

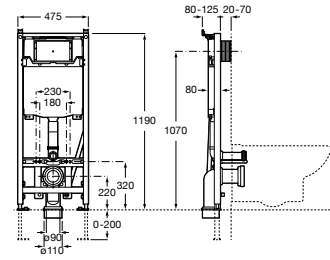

### A890078020

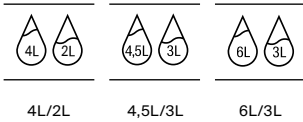

### Duplo WC One Underwindow

Built-in structure for toilet with dual flush system. Elbow  $\varnothing 90/\varnothing 110$ . Metallic profile with load capacity of 400 kg. Installation minimum depth of 160 mm. Adjustable feet from 0-200 mm with braking system. Side hydraulic connections. Flushing mechanism with Dual Cable Technology. To be completed with a compatible Roca PL flush plate (not included).

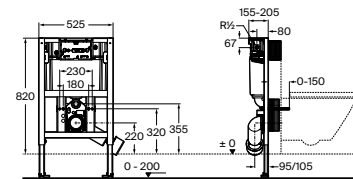

### A890072020

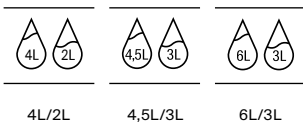

### Basic WC One Compact

Frame with compact dual flush cistern for wall-hung WC.  $\varnothing 90$  /  $\varnothing 110$  elbow. Axial distance of 180 and 230 mm. Minimum depth of 90 mm. Built-in installation in sturdy wall. Top hydraulic connection. To be completed with a compatible Roca flush plate (not included).

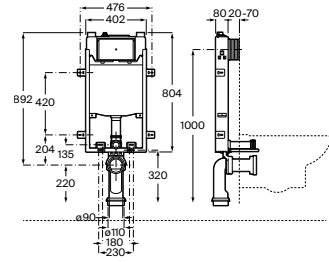

#### A890070120

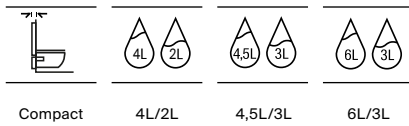

### Basic Tank One Compact

Compact built-in cistern with dual flush for single floorstanding WC. Minimum depth of 80 mm. Installation in partition wall with uprights and/or in front of sturdy wall. Top hydraulic connection. To be completed with a compatible Roca flush plate (not included).

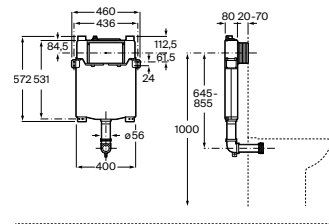

#### A890070200

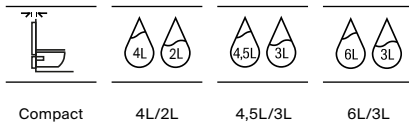

### Basic Tank One Underwindow

Built-in cistern with dual flush for single floorstanding WC. Minimum depth of 140 mm. Installation in sturdy wall. Top hydraulic connection. To be completed with a compatible Roca flush plate (not included).

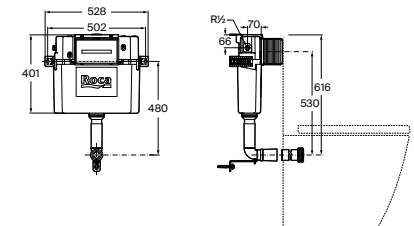

#### A890072200

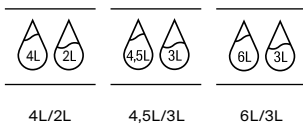



# Duplo Special Frames

**Robust and versatile support solutions are available for a wide variety of bathroom solutions, including urinals, bidets, basins, toilets with integrated tanks and self-closing flushing systems. Featuring easy height adjustments, durable steel frames and compatibility with accessible design standards, Duplo Special Frames offer stability, safety and a clean finish. They provide a solid foundation for modern, space-saving bathroom layouts, whether for public bathrooms or private spaces.**

## Reliable support, flexible configurations

The Duplo for urinals offers a sturdy performance and adjustable installation. It includes versions with integrated flushometers and flush plates are available in standard and premium finishes to complete the solution. Robust and long-lasting, it is the go-to choice for commercial and high-traffic applications.

# Duplo for Urinals



### Duplo S Urinal

Built-in structure for urinal. Installation minimum depth of 105 mm. Metallic profile capable of withstanding 130 kg. Adjustable feet from 0-200 mm with braking system. Adjustable hydraulic connection.

**A8900F4100**

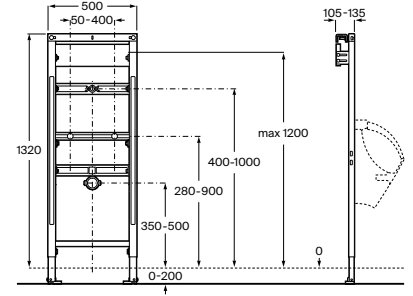

### Duplo S Urinal Fluxor

Built-in structure urinal fluxor single flush valve and installation accessories, installation minimum depth of 105 mm. Metallic profile capable of withstanding 130 kg. Adjustable feet from 0-200 mm with braking system. Adjustable hydraulic connection.

To be complete with PS/ EPS urinal

**A8900F4200**

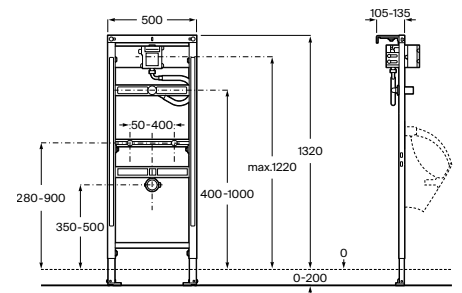

### Duplo Urinal Universal

Built-in structure for urinal. Metallic profile capable of withstanding 130 kg. Minimum installation depth of 140 mm. Installation with uprights and/or in front of sturdy wall. Adjustable feet from 0-200 mm. Height adjustable hydraulic connection.

**A890094100**

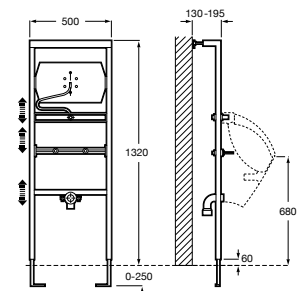

# Integrated design, dependable performance

The Duplo bidet system includes versatile frames for wall-hung bidets, designed to fit shallow walls and ensure full compatibility with any Duplo WC installation. The range includes basic options and more functional solutions, including under-window and compact installation versions. They have a load capacity of up to 400 kg and adjustable hydraulic connections.

## Duplo for Bidets



### Duplo S Bidet

Built-in structure for wall-hung bidet. Installation minimum depth of 90 mm. Metallic profile capable of withstanding 400 kg. Installation minimum depth of 140 mm. Adjustable height feet from 0-200 mm with braking system. Adjustable hydraulic connection.  
**A8900F1200**

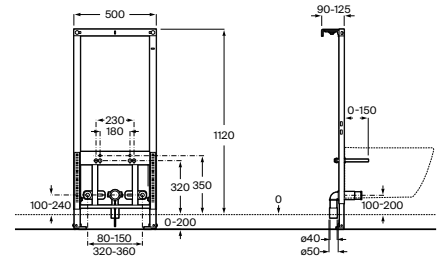

### Duplo S Bidet Underwindow

Low height built-in structure for wall-hung bidet. Installation minimum depth of 155 mm. Metallic profile capable of withstanding 400 kg. Installation minimum depth of 140 mm. Adjustable height feet from 0-200 mm with braking system. Adjustable hydraulic connection..  
**A8900F1201**

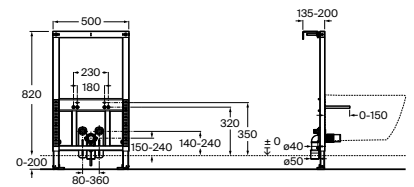

### Basic Bidet

Built-in structure for wall-hung bidet. Axial distance of 180 or 230 mm. Capable of withstanding 400 kg. Minimum installation depth of 120 mm. Built-in installation in sturdy wall. Adjustable hydraulic connection..  
**A890091100**

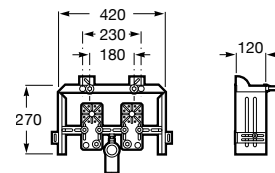

### Supporting Frame

Supporting L-Shape frame for wall-hung WC and wall-hung bidet with an axial distance of 180 mm. Steel profile capable of withstanding 400 kg. To be installed floorstanding and in solid wall.  
**A822091001**

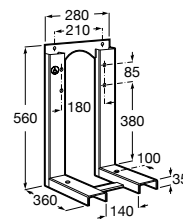

## Slim frame, strong foundation

Duplo basin frames are engineered to support up to 150 kg and are available in slim installation versions. A wide range of user needs are accommodated including reduced mobility requirements by the accessible model with an integrated concealed siphon. An ideal solution for all wall-hung basin configurations.

# Duplo for Basins



---

### Duplo S Basin

Built-in structure for basin. Metallic profile capable of withstanding 150 kg. Installation minimum depth of 90 mm. Adjustable height feet from 0-200 mm with braking system. Adjustable hydraulic connection.

**A8900F3000**

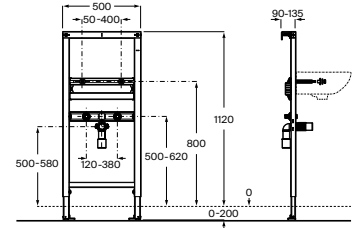

---

### Duplo S Basin Accessible

Built-in structure for basin, for barrier-free construction with siphon in the wall. Metallic profile capable of withstanding 150 kg. Installation minimum depth of 100 mm. Adjustable height feet from 0-200 mm with braking system. Adjustable hydraulic connection. Includes compact siphon for free-barrier installation.

**A8900F3001**

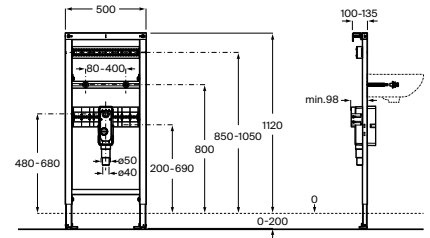
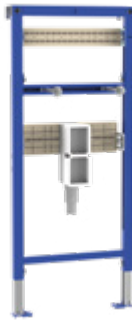

## All-in-one solution, clean integration

Designed specifically for In-Tank® technology, solution features a cistern integrated into the toilet itself. It enables streamlined installation with reduced depth and fewer components, as no external cistern is required. A space-saving solution tailored to Roca's In-Tank® toilet range.

# Duplo for In-Tank®



### Duplo In-Tank®

Built-in structure with integrated dual flush cistern, minimum depth of 107 mm, height 1,190 mm, and elbow  $\varnothing 90 / \varnothing 110$ . Recommended for the installation of Ir Tank® WCs. Installation in partition wall uprights and/or in front of sturdy wall.

**A890078100**

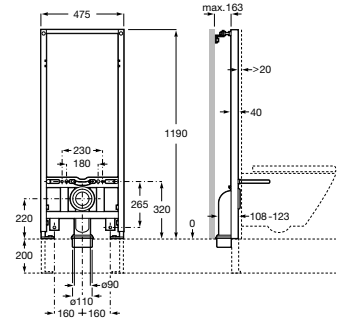

### Supporting Frame L

Supporting L-Shape frame for wall-hung WC and wall-hung bidet with an axial distance of 180 mm. Steel profile capable of withstanding 400 kg. To be installed floorstanding and in solid wall.

**A822091001**

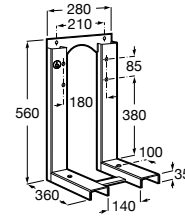

### Supporting Frame I

Supporting I-Shape frame for wall-hung WC and wall-hung bidet with an axial distance of 180 mm. Steel profile capable of withstanding 400 kg. To be installed in solid wall.

**A822091021**

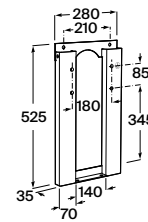

## Valve-based flushing, wall integration

These frames integrates self-closing WC flush valve systems and offers a sturdy, water-saving solution for high-traffic installations. With both manual and electronic options.

# Duplo for Self-closing WC Flush Systems

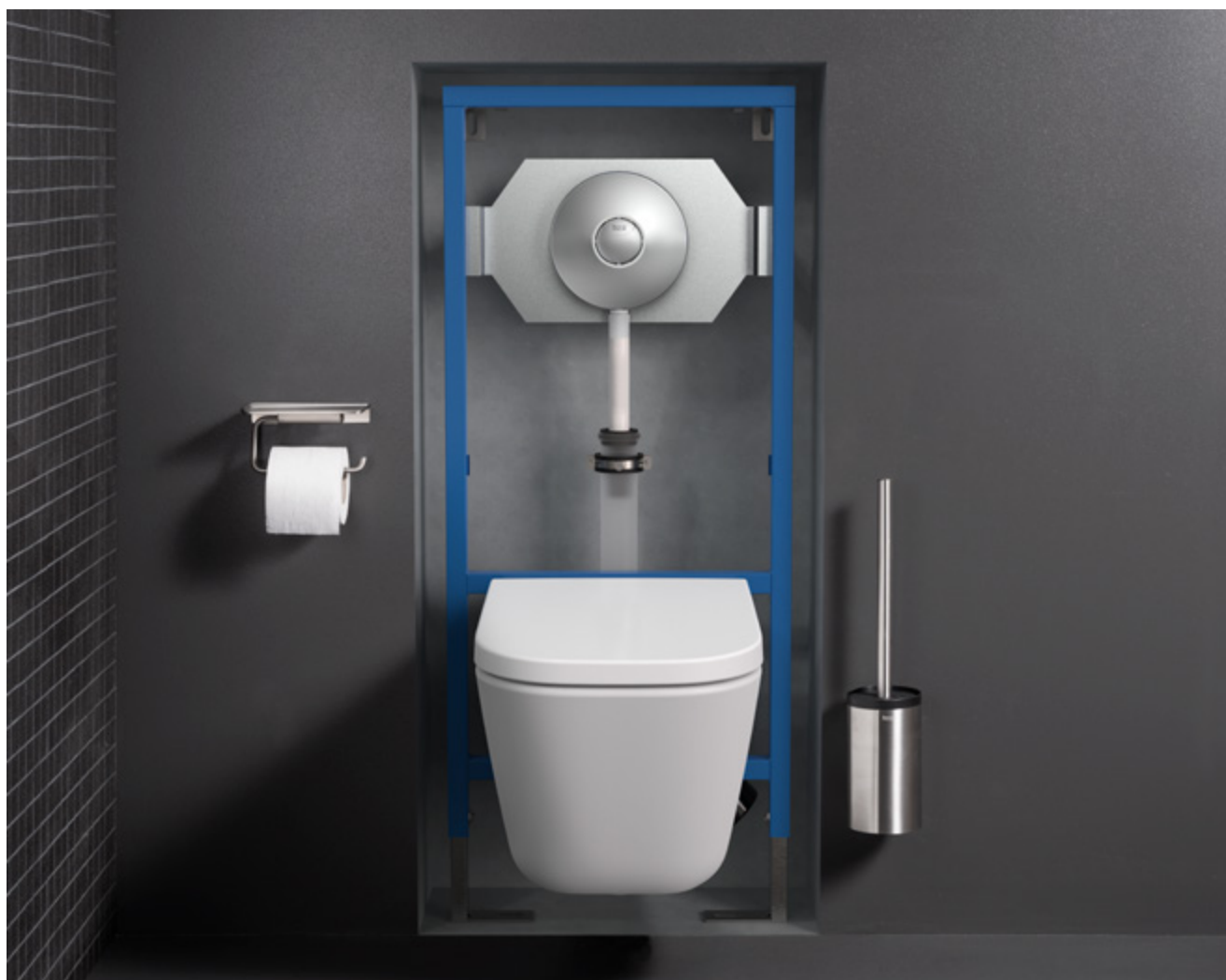

Duplo WC Fluxor-E (Electronic)

Built-in structure for wall-hung WC with dual flush valve and installation accessories,  $\varnothing 90$  /  $\varnothing 110$  elbow. Electronic and manual operation. Minimum depth of 140 mm. Installation in partition wall with uprights and/ or in front of sturdy wall.

**A890092200**

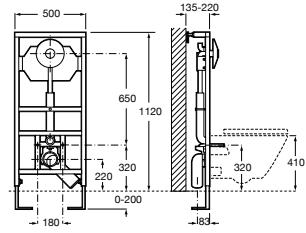
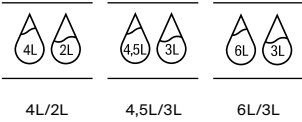

Duplo WC Fluxor

Built-in structure for wall-hung WC with dual flush valve and installation accessories. Axial distance of 180 mm. Metallic profile capable of withstanding 400 kg. Minimum depth of 140 mm. Adjustable feet from 0-200 mm with braking system.  $\varnothing 90$  /  $\varnothing 110$  elbow. Installation in partition wall with uprights and/ or in front of sturdy wall.

**A890092100**

*Optional:*

*Vandal-proof stainless steel kit for Duplo WC*

*Fluxor.*

**A890065004**

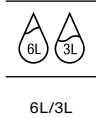
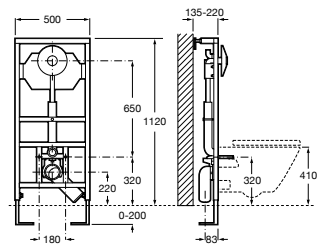

Duplo WC Fluxor Single Flush

Built-in structure for wall-hung WC with single flush valve and installation accessories. Axial distance of 180 mm. Metallic profile capable of withstanding 400 kg. Minimum depth of 140 mm. Adjustable feet from 0-200 mm with braking system.  $\varnothing 90$  /  $\varnothing 110$  elbow. Installation in partition wall with uprights and/or in front of sturdy wall.

**A890092300**

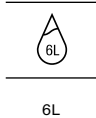
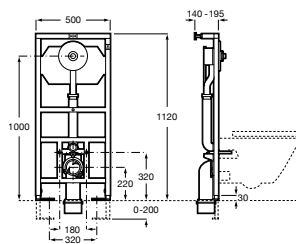

## Support structure for grab bar use

Accessory frame for installing grab bars alongside Duplo systems. It is engineered for durability and safe use, meeting accessibility standards.

# Duplo Accessible



### Duplo Accessible

Built-in structure for installing a grab bar.  
Designed to adapt to one side of the  
Duplo systems. Metallic profile capable of  
withstanding 100 kg. Adjustable feet from  
0-200 mm.

**A890090600**

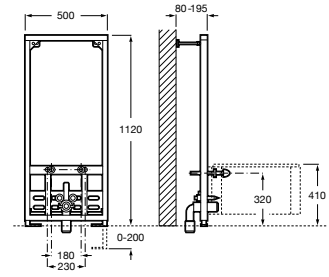



Roca

# Prefab Systems

**Precision, performance and efficiency for  
comprehensive projects**

Prefab systems are ideal for large-scale construction projects that demand high quality results and efficient solutions. Whether for new developments or renovation projects, Prefab systems are especially advantageous in buildings with repetitive layouts and projects that feature multiple units.

---

**Residential complexes and hotels**

---

**Retirement residences and healthcare facilities**

---

**Office buildings**

---

**Public institutions**



# For projects with unique or complex requirements

Thanks to high-standard industrial prefabrication, Prefab systems ensure full compliance with regulations and delivers outstanding performance in critical areas such as fire safety, acoustics, and hygiene.

Fire protection is a fundamental aspect of the Prefab systems. Roca incorporates only premium, certified materials to ensure the highest level of fire safety. For projects with unique or complex requirements, our specialists are available to develop customized fire protection solutions tailored specifically to meet the needs of the entire construction project.

Each construction site has distinct acoustic challenges. Through careful planning and precise coordination of all system components, Prefab systems optimal sound insulation that complies with the strict standards of DIN 4109 and VDI 4100, ensuring a comfortable and quiet indoor environment.

All components within the Prefab systems fully comply with the latest drinking water hygiene standards, providing consistently safe and clean water supply. Additionally, Roca offers comprehensive technical planning support to address any advanced hygiene requirements that may arise during project development.





# Project-Focused Benefits

## Key advantages at a glance

### **Assured quality:**

- High-quality, regulation compliant components.

### **Customized**

- Individually preassembled components tailored to each project.

### **Cost-Efficient**

- Transparent cost estimates with no hidden fees.
- Reduced labor requirements.
- Potential savings on rental loss thanks to off-site fabrication.

### **Easy Installation**

- All systems delivered ready-to-install in a self-supporting frame.
- Delivered complete with all necessary installation accessories included.
- Accurate budgeting and cost control.

### **On Time**

- Fixed delivery schedule aligned with project timelines.
- Streamlined integration into construction workflows.
- Faster project completion and commissioning.

### **Reliable Support Team**

- Our experts are available to guide you throughout every step of the planning process.
- Comprehensive support and consulting from materials to products and installation.
- A support team that you can trust and depend on.



Roca

Roca

Roca

Roca

Roca

# Product Finishes

# Flush Plates

---



0 White



2 Chrome Matt



1 Chrome



4 Stainless Steel



6 Matt Black

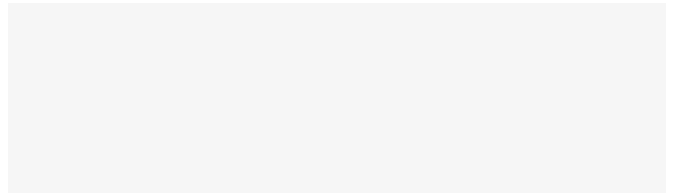

7 Matt White

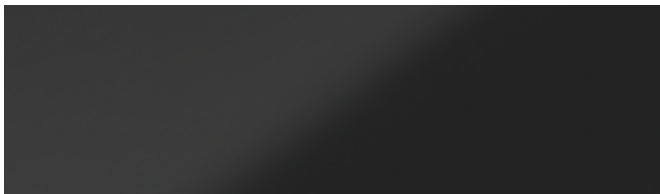

8 Black Glass



9 White Glass



OP / 63 Pearl



64 Onyx

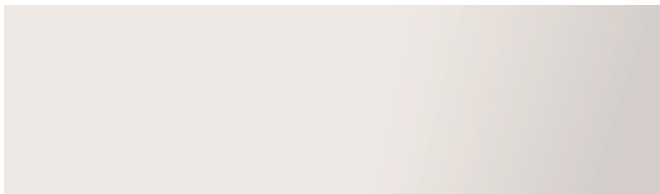

OB / 65 Beige



OM / 66 Coffee



CN Titanium Black



NM Brushed Titanium Black



RG Rose Gold



VA Brushed Brass



4A/AA Anthracite Glass



SS Slate



OO Oak



MM Marble



CC Concrete

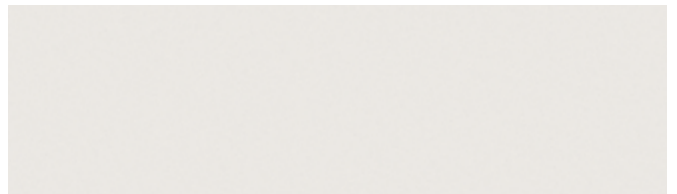

DD White Ceramic

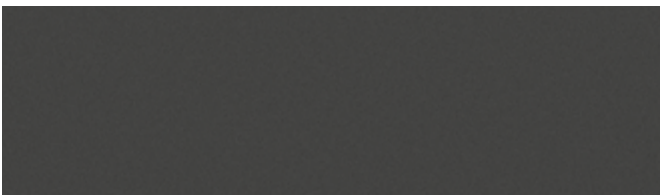

EE Black Ceramic



P0 Cobalt Blue



P1 Honey Yellow



P2 Mint Green



Our Planet



Our Home

We are committed to putting people and the planet at the center of every decision we make. Because creating a sustainable future starts with the spaces we live in, and how we produce these spaces is key. That's why we craft products that bring comfort, beauty, and balance to your home, while protecting the planet every step of the way.

Every detail matters: from eco-designing products that last a lifetime to minimizing emissions, using clean energy, and reducing water and resource consumption. We believe that a home – whether our own or the planet we all share – should be a place of wellbeing, harmony, and care. This belief guides our comprehensive approach to sustainability, which involves taking a wide range of actions, such as reusing and recycling more, improving our processes, and ensuring access to water and sanitation for those who need it most, among many other initiatives.

## EcoDesign

---

**Eco-designing for efficiency and circularity: fostering products that are built to last, repairable, and recyclable.**

We create long-lasting products with easy-to-replace parts, ensuring extended usability and reducing waste.

Our Life Cycle Assessments (LCA) and Environmental Product Declarations (EPD) provide transparency on our products' environmental footprint.

We design products for easy disassembly and recyclability, such as 100% recyclable shower enclosures, fostering responsible waste management.

Our innovative technologies reduce water and energy consumption, supporting sustainable building certifications such as LEED and BREEAM.

## Responsible Production

---

**Preserving natural resources goes beyond using water efficiently. It begins with sustainable production.**

We are moving towards emission-free factories with pioneering technologies, including the world's first electric tunnel kiln for sanitary ceramics, aiming for net-zero emissions by 2045.

We rely on renewable energy sources, including Power Purchase Agreements (PPAs) and on-site photovoltaic panels, to minimize our carbon footprint.

Our water neutrality roadmap focuses on reducing, reusing, and recycling water to minimize freshwater consumption.

We reintegrate manufacturing byproducts like chamotte and brass swarf into our production and promote waste reuse across industries to minimize landfill waste.

## Commitment to society

---

**Enhancing people's lives and building a healthier, more inclusive, and sustainable future.**

We develop solutions for people with functional diversity, reduced mobility, and special needs to ensure comfort, independence and dignity.

Our products and services are designed to promote wellbeing, self-care, and a healthier lifestyle.

Through the We Are Water Foundation, we strive to improve access to clean water and sanitation for those in need.

Through Roca Galleries, we promote global dialog that inspires sustainable design, architecture, and urban planning.

# Protecting our home means safeguarding our people and our planet

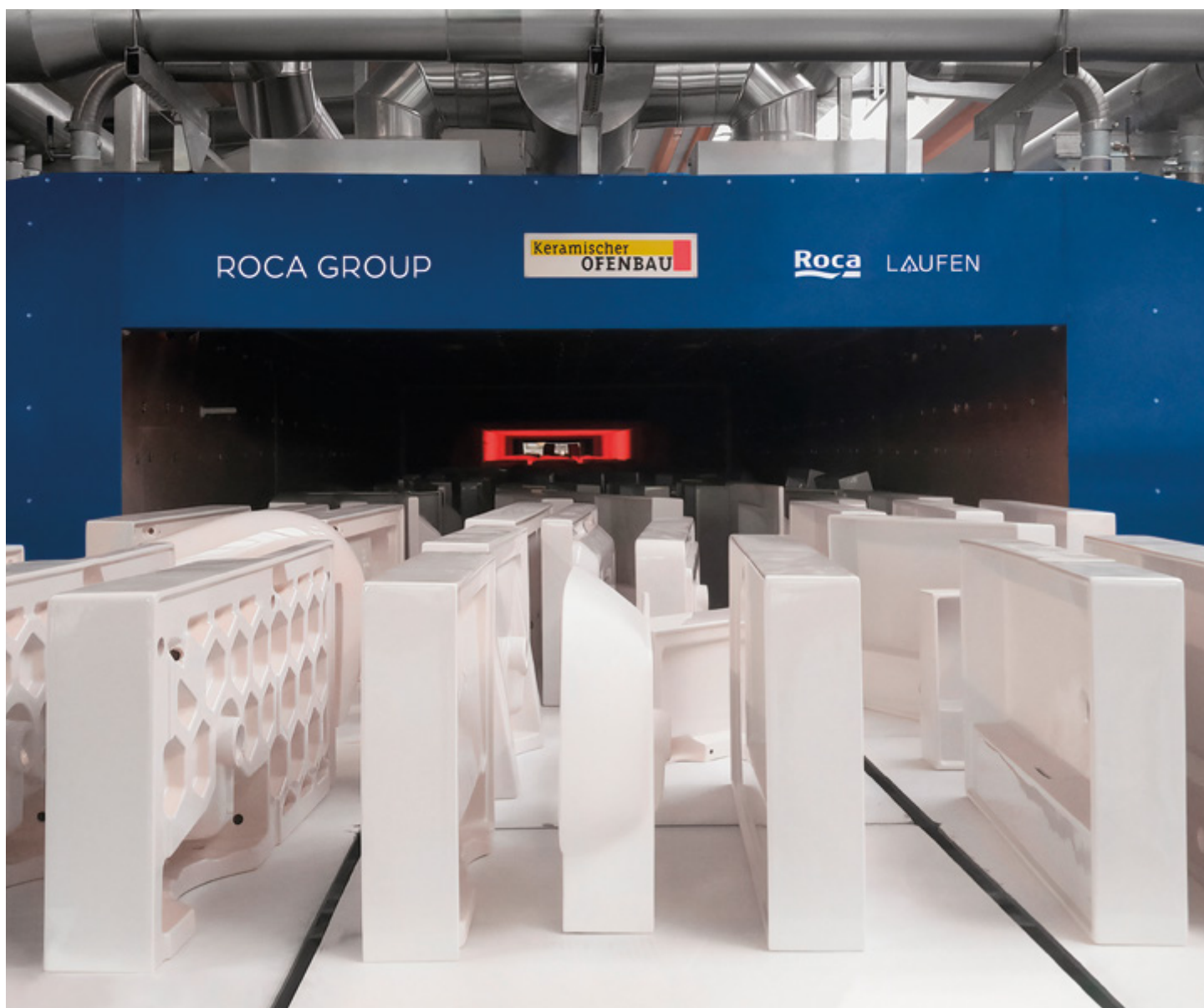

Our commitment is to create products that bring comfort, and balance to your home, while protecting the planet we all share.

**2045**

**Net-zero ambition**  
World's first electric tunnel kiln in operation

**53%**

decrease in scopes 1 + 2 CO<sub>2</sub> emissions

**55%**

decrease in energy use intensity

**41,000+**

PV panels onsite generating **21.2+ GWh** renewable energy per year

**54%**

decrease in water consumption\*

**58%**

decrease in water use intensity\*

**78%**

of valorised wasted\*

**58%**

drop in waste generation intensity\*\*

\*Between 2018 and 2024 | \*\*FY2024



Our EcoVadis Platinum Medal for outstanding sustainability performance places Roca Group among the top 1% of over 150,000 companies assessed globally.



We are committed to taking action for the Sustainable Development Goals as proud members of the United Nations Global Compact.



**Roca is a family-owned company dedicated to the design, manufacturing, and sale of bathroom solutions for architecture, construction, and interior design. Founded in Barcelona in 1917, it combines tradition and knowledge with a passion for innovation and respect for the environment.**

**With sustainability as a key element in all its processes and a commitment to ensure a better planet for future generations, Roca is present in 170 countries, operating 79 factories across the five continents with more than 20,000 employees.**

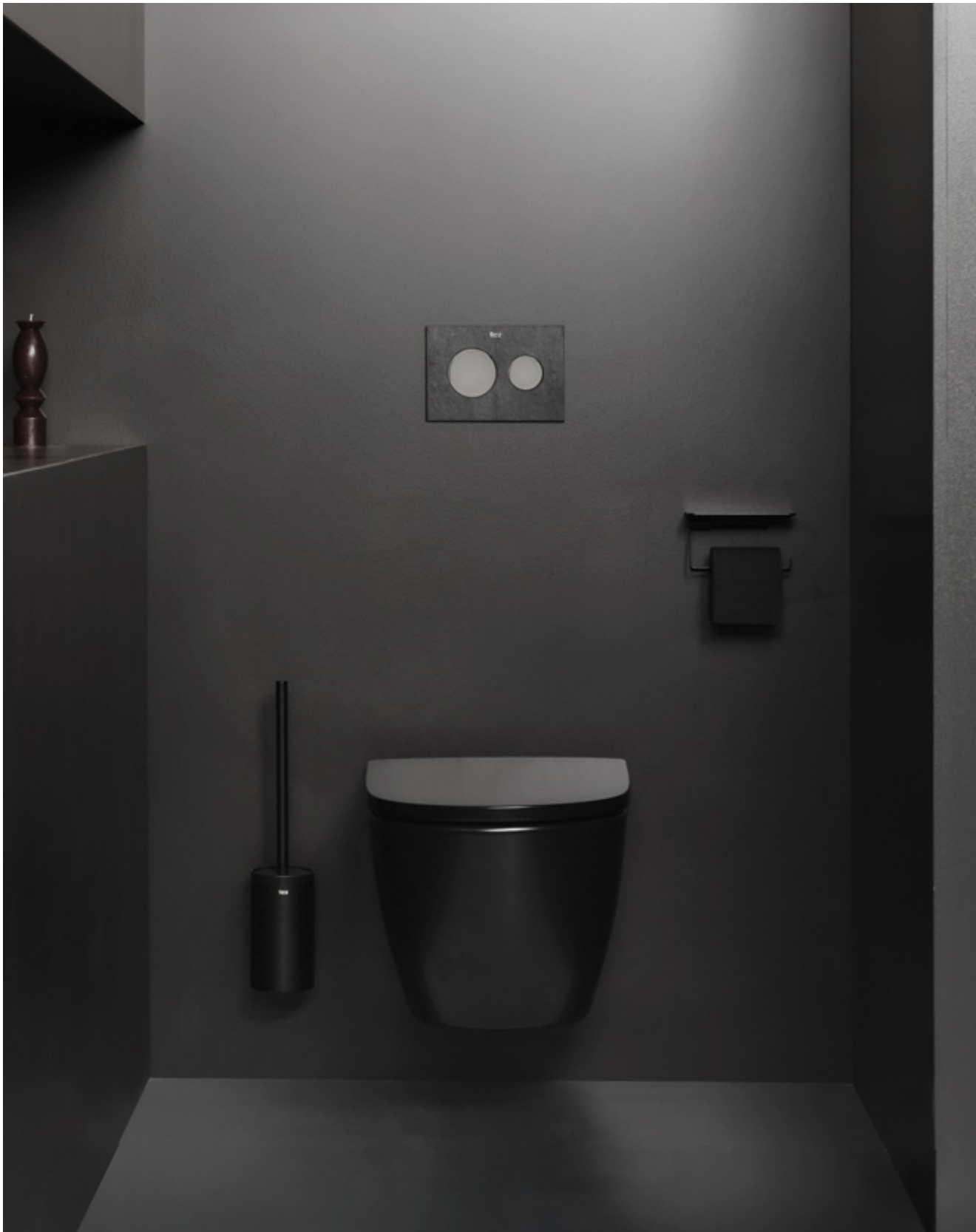

Installation  
Systems



@roca\_global



in

@roca



f

@rocaglobal

**Roca**